



**ANDERSEN<sup>®</sup> A-SERIES WINDOW AND PATIO DOORS  
 WITH STORMWATCH<sup>®</sup> PROTECTION  
 CUSTOM-SIZE MINIMUM & MAXIMUM DIMENSIONS**

Casement Windows . . . . . 2  
 Awning Windows . . . . . 2  
 Double-Hung Windows . . . . . 3 - 4  
 Picture Windows . . . . . 5  
 Transom Windows . . . . . 5  
 Gliding Patio Doors . . . . . 6  
 Hinged Patio Doors . . . . . 7 - 8

For information on clear opening dimensions, visit [www.andersenwindows.com\clearopening](http://www.andersenwindows.com\clearopening).

For the most up-to-date version of this document go to [www.andersenwindows.com](http://www.andersenwindows.com).

# CUSTOM-SIZE MINIMUMS & MAXIMUMS AVAILABLE IN 1/8" INCREMENTS

## Casement Windows with Stormwatch® Protection

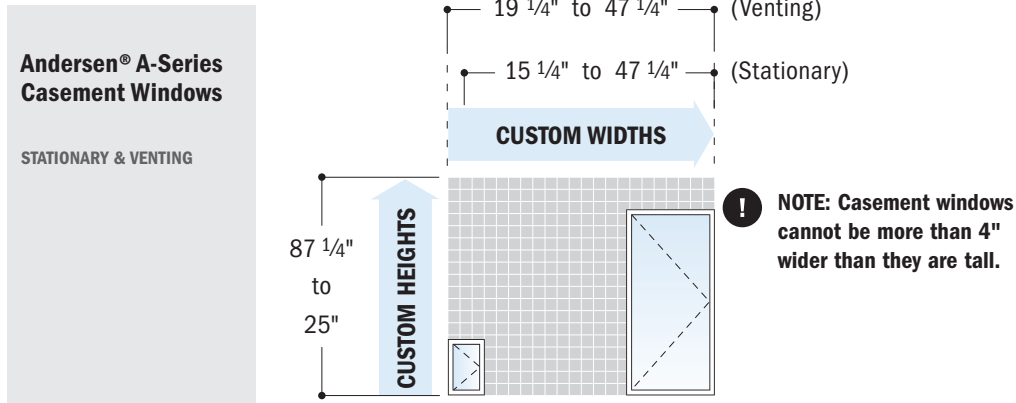

## Awning Windows with Stormwatch® Protection

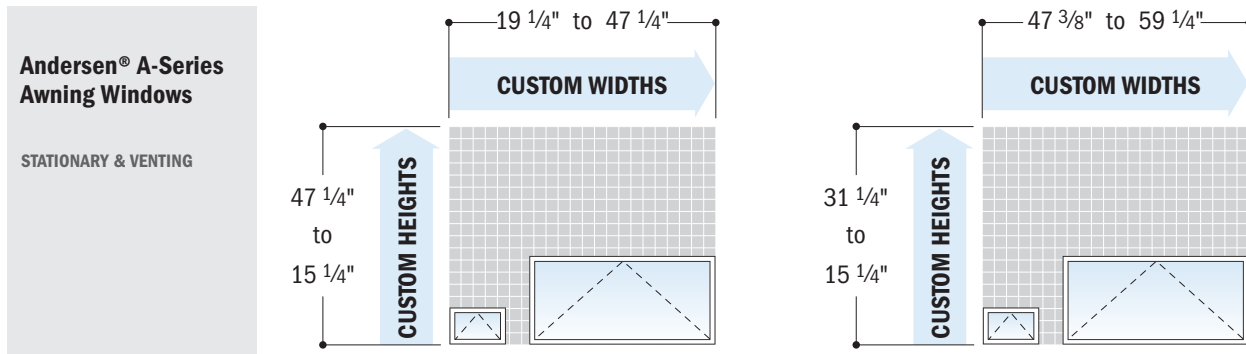

## Double-Hung Windows with Stormwatch® Protection

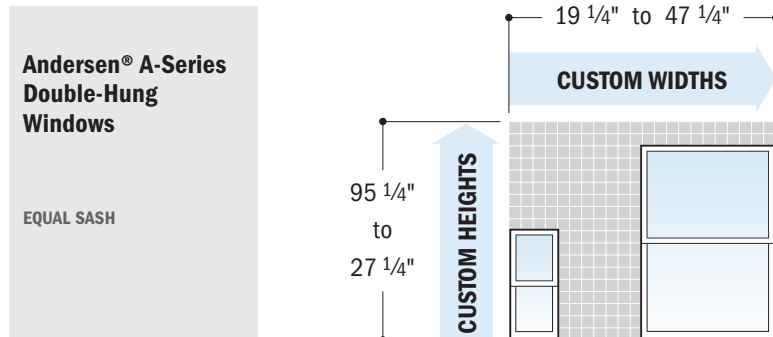

## Double-Hung Windows with Stormwatch® Protection (continued)

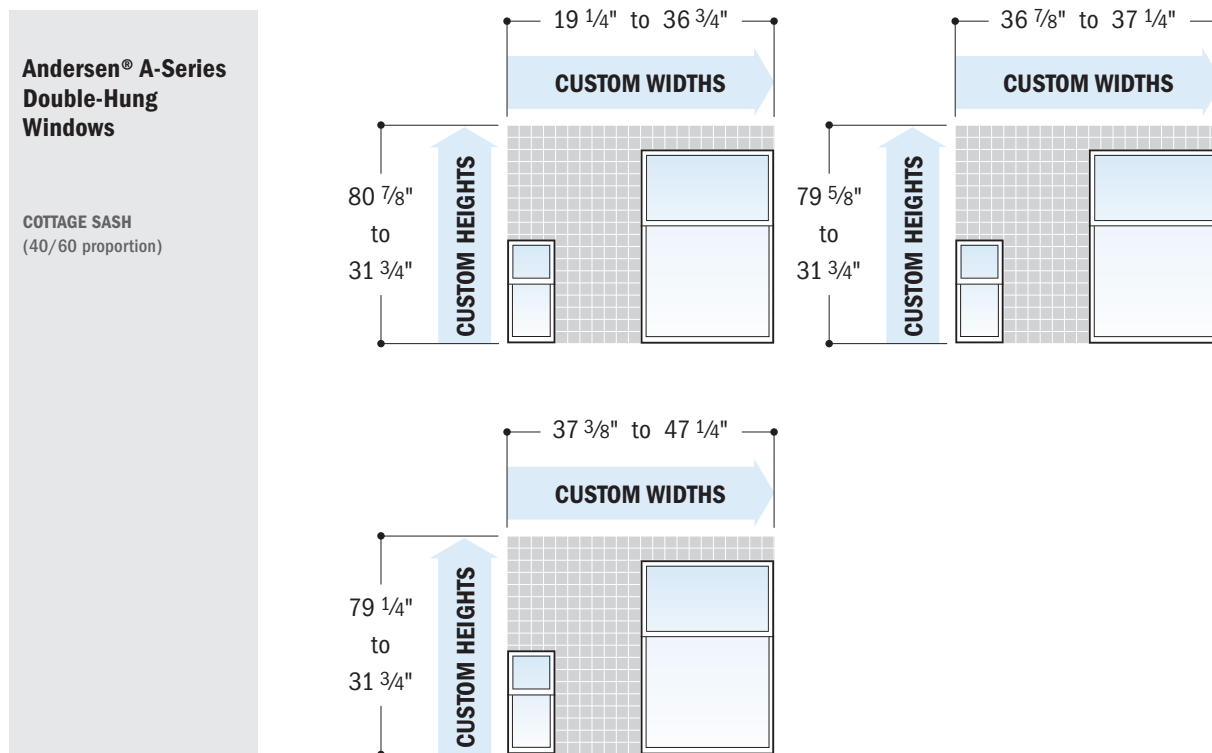

## Double-Hung Windows with Stormwatch® Protection (continued)

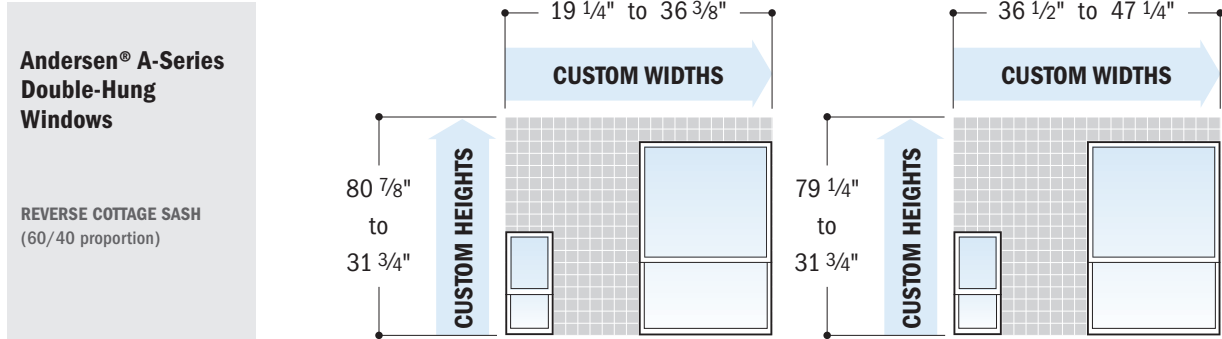

# CUSTOM-SIZE MINIMUMS & MAXIMUMS AVAILABLE IN 1/8" INCREMENTS

## Picture Windows with Stormwatch® Protection

Andersen® A-Series  
Picture Windows

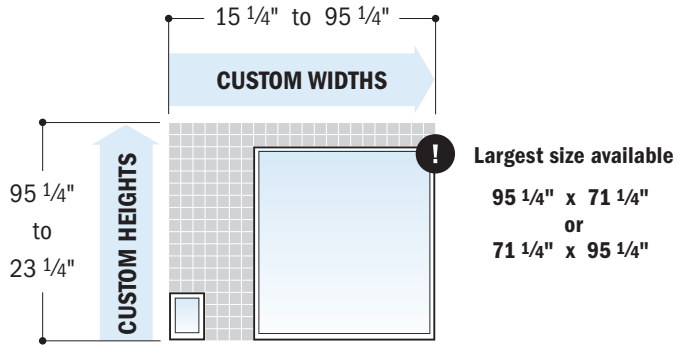

## Transom Windows with Stormwatch® Protection

Andersen® A-Series  
Venting Transom  
Windows

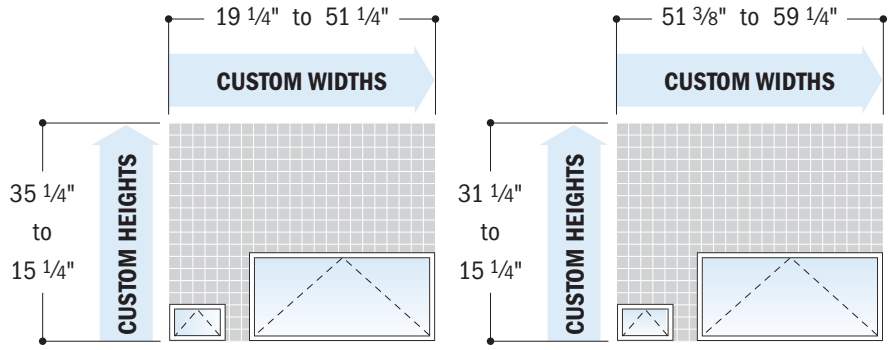

Andersen® A-Series  
Fixed Transom  
Windows

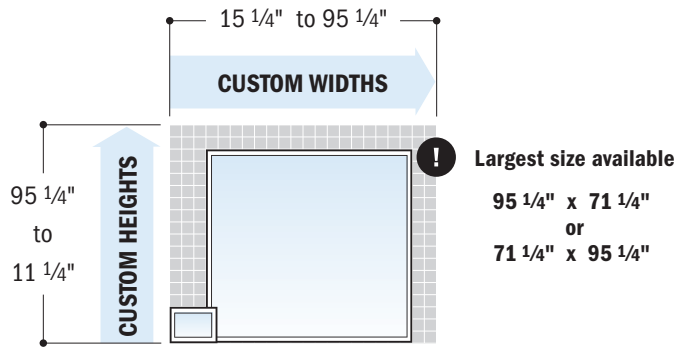

## Gliding Patio Doors with Stormwatch® Protection

**Andersen® A-Series Frenchwood® Gliding Patio Doors**

SINGLE STATIONARY PANEL (SIDELIGHT)

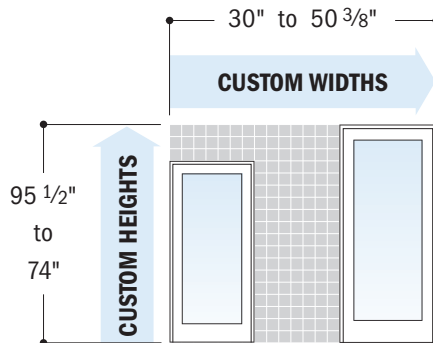

**Andersen® A-Series Frenchwood® Gliding Patio Doors**

2-PANEL

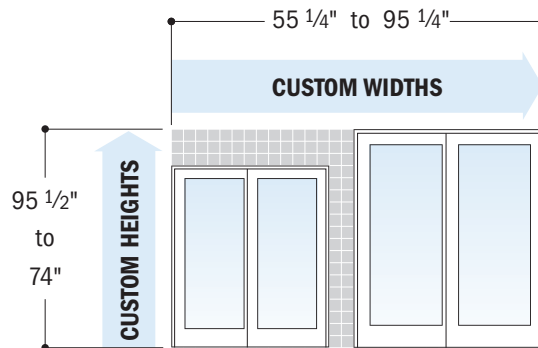

**Andersen® A-Series Frenchwood® Gliding Patio Doors**

3-PANEL

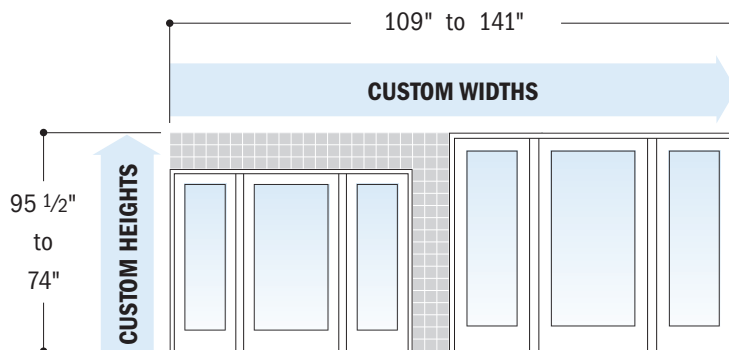

**Andersen® A-Series Frenchwood® Gliding Patio Doors**

4-PANEL

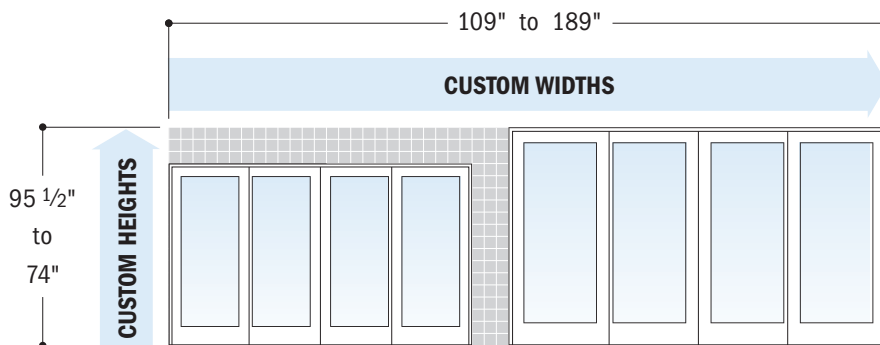

# CUSTOM-SIZE MINIMUMS & MAXIMUMS AVAILABLE IN 1/8" INCREMENTS

## Hinged Patio Doors with Stormwatch® Protection

**Andersen® A-Series Frenchwood® Hinged Patio Doors Inswing & Outswing**

SINGLE PANEL & SINGLE STATIONARY PANEL

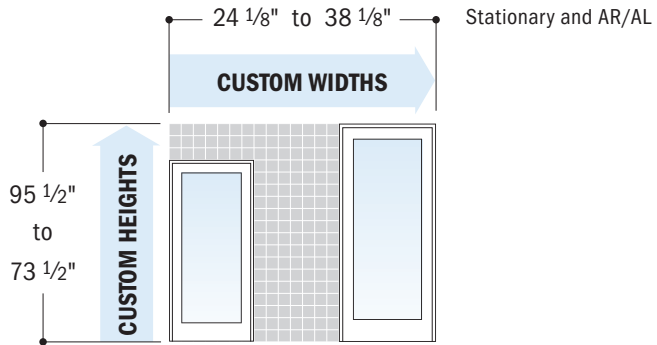

**Andersen® A-Series Frenchwood® Hinged Patio Doors Inswing & Outswing**

2-PANEL

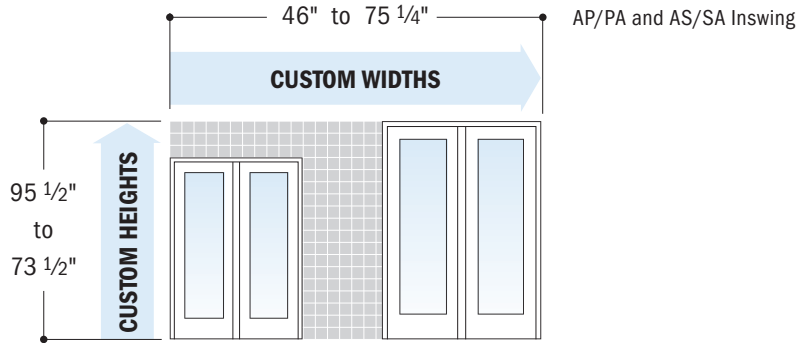

**Andersen® A-Series Frenchwood® Patio Door Transom**

SINGLE

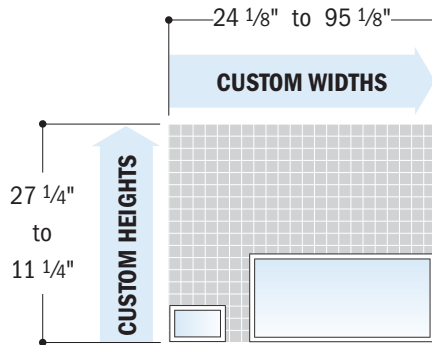

**Andersen® A-Series Frenchwood® Patio Door Transom**

DOUBLE

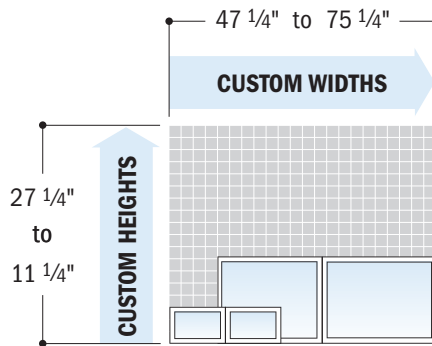

For information on clear opening dimensions, visit [www.andersenwindows.com/clearopening](http://www.andersenwindows.com/clearopening).  
For the most up-to-date version of this document go to [www.andersenwindows.com](http://www.andersenwindows.com).

## Hinged Patio Doors with Stormwatch® Protection (continued)

Andersen® A-Series  
Frenchwood®  
Patio Door  
Sidelight

