

Stiffener Installation Guide

for Andersen® 400 Series Frenchwood® Gliding Patio Door Stationary Panel Replacement with Stormwatch® Protection (Monolithic Impact Resistant Glass)

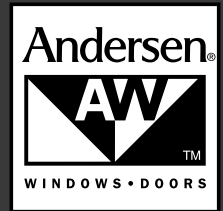

IMPORTANT

Read all instructions carefully before attempting this procedure. If you have any questions about your ability to complete this procedure, call Andersen at 1-888-888-7020 for further direction. Andersen WindowCare® service center hours are Monday through Friday, 7 a.m. to 7 p.m. Central Time and Saturday, 8 a.m. to 4 p.m. Central Time. Thank you for choosing Andersen® products.

Important Safety, Assembly, and Installation Information

Every assembly and installation is different (windloads, structural support, etc.), and Andersen strongly recommends consultation with an Andersen supplier or an experienced contractor, architect, or structural engineer prior to the assembly and installation of any Andersen product. Andersen has no responsibility in regard to the post-manufactured assembly and installation of Andersen products.

⚠ WARNING

Use of ladders and/or scaffolding and working at elevated levels may be hazardous. Follow equipment manufacturer's instructions for safe operation. Use extreme caution when working around window and door openings. Falling from opening may result in personal injury or death.

⚠ WARNING

Improper use of hand or power tools could result in personal injury and/or product damage. Follow equipment manufacturer's instructions for safe operation. Always wear safety glasses.

⚠ WARNING

Weight of window and door unit(s) and accessories will vary. Use a reasonable number of people with sufficient strength to lift, carry, and install window and door unit(s) and accessories. Always use appropriate lifting techniques.

⚠ CAUTION

- Steel fasteners will corrode when used with ACQ Pressure Treated Lumber.
- Obtain and use the appropriate size stainless steel fasteners, as called out in this installation guide, to fasten unit to any rough opening made from ACQ Pressure Treated Lumber.
- Failure to use stainless steel fasteners may result in fastener corrosion causing product damage.

NOTICE

Interior surface and trim must be finished (painted, stained, etc.). Finishing prior to installation is recommended. Refer to finishing manufacturer's instructions and warnings. Exterior surfaces with Perma-Shield® cladding do not need to be finished.

NOTICE

- Interlock Weatherstrip must be removed from existing panel for use on replacement panel.
- This instruction guide applies to panels with Monolithic Impact Resistant Glass dated before May 2005.

Parts Included - Stationary Panel

- (1) Instruction Guide
- (1) Stationary Panel Stiffener
- (1) Universal Stiffener Bracket
- (5) #10 x 1" Screws (Stainless)
- (6) #10 x 2" Screws (Color Matching)
- (11) #7 x 5/8" Screws (Color Matching)

Components Identified

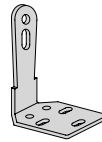

Universal Stiffener Bracket
(2579406) Stainless

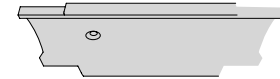

Stationary Panel Stiffener

Tools & Supplies

- Safety Glasses
- Hammer
- Caulk Gun
- Power Drill
- 1/16" Drill Bit
- 1/8" Drill Bit
- Phillips Screwdriver
- Flat Head Screwdriver
- Finish Nails
- Nail Set



#7 x 5/8" Screws* (color matching)
(1973109) White, (2641210) Gray

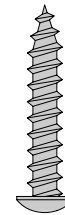

#10 x 1" Screws
(2579405) Stainless

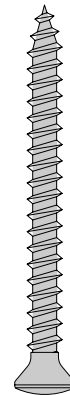

#10 x 2" Screws (color matching)
(2579403) White, (2633869) Terratone® (0912719) Sandtone,
(1269111) Forest Green, (2579404) Beige

* Screws used to reinstall existing Interlock Weatherstrip on replacement panel.

NOTICE

Replacement Stationary Panel must be installed before the Stationary Panel Stiffener can be installed. Refer to panel assembly and installation for Andersen® Frenchwood® Gliding patio Doors with Stormwatch® protection (High-Performance™ Impact Resistant or Monolithic Impact Resistant Glass) for instructions.

1. Apply Stationary Panel Edge Stiffener

- Position painted *Stationary Panel Stiffener* on *Stationary Panel* edge, over *Stationary Panel Interlock Weatherstrip*.
- Fasten *Stationary Panel Stiffener* in position using one *#10 x 2" Color Matched Oval Head Screw* in third hole up from bottom.

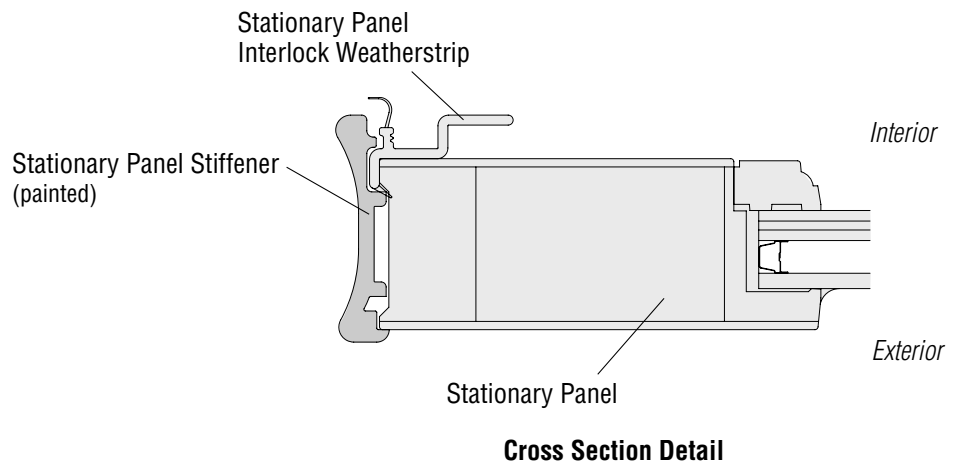
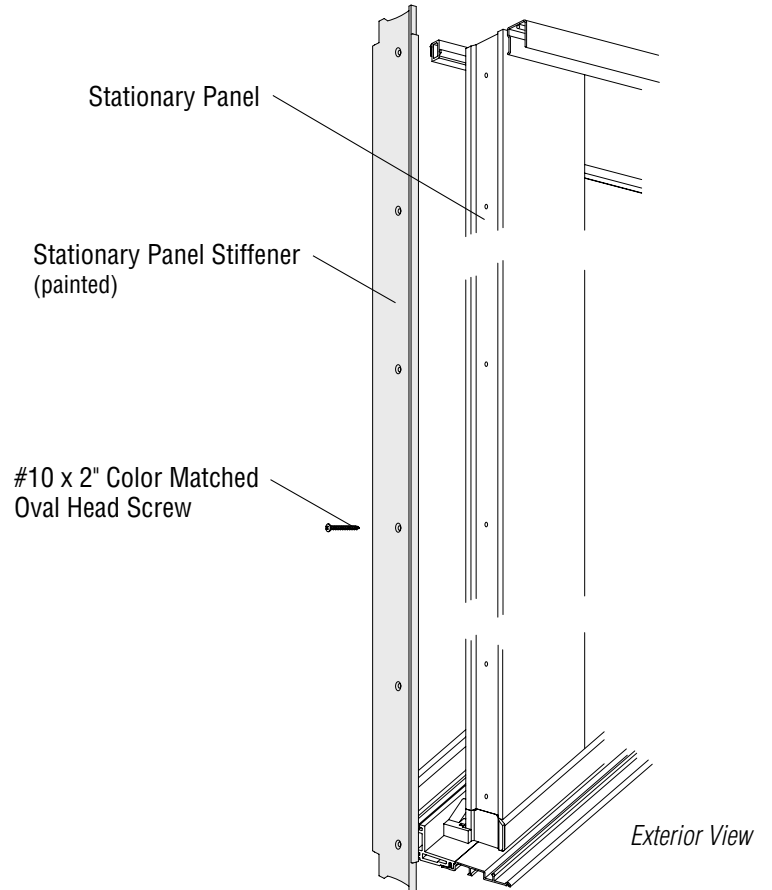

2. Apply Head Bracket

- Insert *Head Bracket* by pulling back top of *Stationary Panel Stiffener* and positioning bracket behind it.
- Fasten *Head Bracket* to panel using one *#10 x 2" Color Matched Oval Head Screw*. Align slotted holes in *Head Bracket* with predrilled holes in head jamb and fasten using three *#10 x 1" Stainless Pan Head Screws*. Repeat for remaining two holes in *Head Bracket*.

⚠ CAUTION

- Steel fasteners will corrode when used with ACQ Pressure Treated Lumber.
 - Obtain and use the appropriate size stainless steel fasteners, as called out in this installation guide, to fasten unit to any rough opening made from ACQ Pressure Treated Lumber.
 - Failure to use stainless steel fasteners may result in fastener corrosion causing product damage.
- Fasten *Stationary Panel Stiffener* using *#10 x 2" Color Matched Oval Head Screws* in remaining holes.

