

**What's in This Section**

<b>Double-Hung, Picture &amp; Transom Insert Windows</b> .....	<b>Page 3</b>
<b>Parts Illustration</b> .....	<b>3</b>
<b>Unit Sizes</b> .....	<b>4</b>
<b>Product Label</b> .....	<b>5</b>
Woodwright Product Label .....	5
<b>Complete Insert Windows</b> .....	<b>6</b>
Complete Insert Window .....	6
<b>Sash</b> .....	<b>7</b>
Sash - Upper or Lower .....	7
Weatherstrip .....	7
Sash Hardware .....	8
<b>Sash Balancers</b> .....	<b>11</b>
Sash Balancers .....	11
Sash Balancer Hardware .....	14
<b>Glass</b> .....	<b>15</b>
Glass - Picture and Transom Units .....	15
<b>Insect Screens</b> .....	<b>16</b>
Insect Screen - Full .....	16
Insect Screen - Half .....	17
<b>Grilles</b> .....	<b>19</b>
Interior Grilles .....	19
Exterior Grilles - HDN .....	20
<b>Frames</b> .....	<b>21</b>
Complete Frames .....	21
Stops .....	21
Filler Kit .....	22
Weatherstrip - Double-Hung Units .....	23
Frame Parts .....	24
<b>Joining Components</b> .....	<b>26</b>
Narrow Joining Parts .....	26
Universal Drip Cap - Continuous .....	27
<b>Installation Materials</b> .....	<b>28</b>
Installation Materials .....	28
 <b>Service Replacement</b> .....	 <b>Page 31</b>

<b>Service Replacement Only</b> .....	<b>31</b>
Sash Interlocks - Upper and Lower .....	31
Service Materials .....	32
Jamb Liners .....	32
Weatherstrip - Double-Hung Units .....	33

Double-Hung, Picture & Transom Insert Windows

**Parts Illustration**

---

**Parts Illustration**



**Manufactured 2005 to Present**

**Woodwright Double-Hung, Picture & Transom Insert Window Unit Parts**

*Unit viewed from exterior.*

## Unit Sizes

### Unit Size Chart

Woodwright® Double-Hung Insert Window Size Range Scale 1/8" = 1'-0" (1:96)

#### EQUAL SASH UNIT SIZES

Unit height limits depend on new insert unit sill angle.

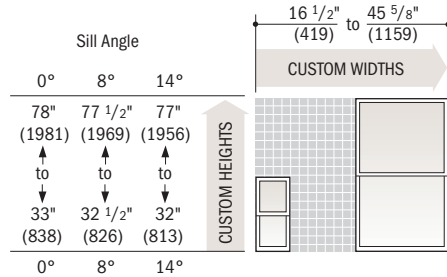

#### COTTAGE OR REVERSE COTTAGE SASH UNIT SIZES

Unit height limits depend on new insert unit sill angle.

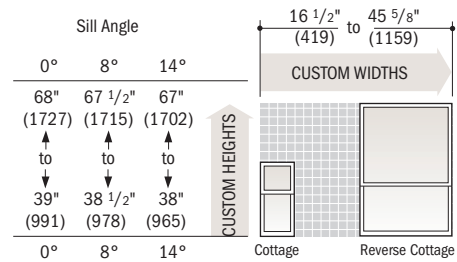

#### PICTURE UNIT SIZES

Picture window height limits depend on new insert unit sill angle.

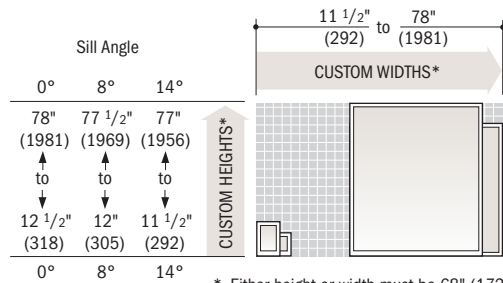

\* Either height or width must be 68" (1727) or less.  
Height plus width cannot be less than 28" (711).

#### TRANSOM UNIT SIZES

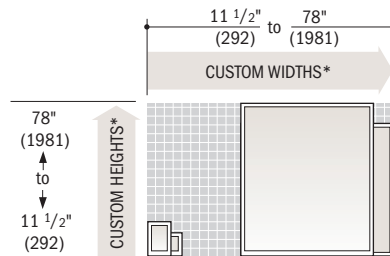

\* Either height or width must be 68" (1727) or less.  
Height plus width cannot be less than 28" (711).

- Dimensions in parentheses are in millimeters.
- When ordering, be sure to specify color desired: White, Sandtone, Terratone® or Forest Green.

### Woodwright Double-Hung, Picture & Transom Insert Window Unit Sizes

## Product Label

### Woodwright Product Label

Each Woodwright Insert Window has a unique identification number found on the permanent label. The label on a double-hung insert is located in the upper left corner of the upper sash head jamb track. The label on a picture or transom unit is located under the side stop in the lower right-hand corner.

To ensure that replacement parts match the specifications of the original product, provide both the **ID #** and the **Product ID** when ordering replacement parts.

#### Pre-2009 Label

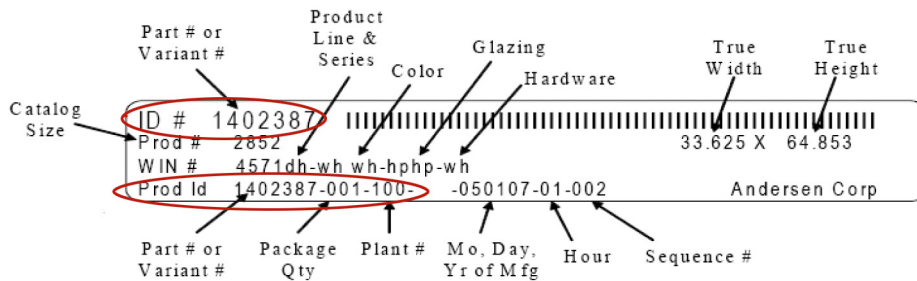

#### 2009 to Present



**Product ID**

## Complete Insert Windows

<b>Complete Insert Window</b>	
<b>Complete Insert Window</b>	
	<p><b>Note:</b> All Woodwright insert windows are made to order.</p> <p>Perma-Shield Narroline and Primed Narroline windows one-step and two-step sills are at a 14° angle.</p> <p><b>Exterior color options:</b> White, Terratone®, Sandtone, or Forest Green</p> <p><b>Interior finish options:</b> Pine, Maple, Oak, or Prefinished White</p> <p><b>Glass options:</b> High-Performance™ Low-E, High-Performance Low-E Tempered, High-Performance Sun™ Low-E, and High-Performance Sun Low-E Tempered, and additional special glazings</p> <p><b>Factory applied grille options:</b> Finelight™ grilles-between-the-glass High-definition grilles - Full divided light with spacer Simulated divided light without spacer Exterior grilles</p> <p><i>To order, state:</i></p> <ol style="list-style-type: none"> <li>1. <b>Description of Part (Complete Insert)</b></li> <li>2. <b>Quantity</b></li> <li>3. <b>Product ID (from product label, <a href="#">see page 5</a>)</b></li> <li>4. <b>Options Desired</b></li> </ol>

### Sash - Upper or Lower

#### Sash - Upper or Lower

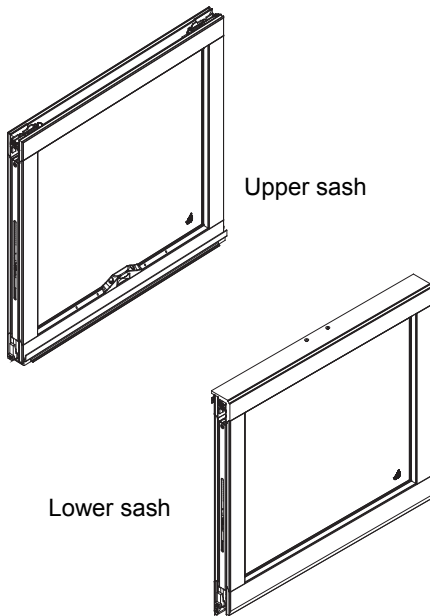

**Note:**

Replacement sash is made to order. Sash comes with balancers, lock, and tilt latches. Upper and lower replacement sashes can be ordered separately.

**Exterior color options:**

White, Terratone®, Sandtone, or Forest Green

**Interior finish options:**

Pine, Maple, Oak, or Prefinished White

**Glass options:**

High-Performance™ Low-E, High-Performance Low-E Tempered, High-Performance Sun™ Low-E, and High-Performance Sun Low-E Tempered, and additional special glazings

**Factory applied grille options:**

Finelight™ grilles-between-the-glass  
 High-definition grilles - Full divided light with spacer  
 Simulated divided light without spacer  
 Exterior grilles

*To order, state:*

1. Description of Part (upper or lower sash)
2. Quantity
3. Product ID (from product label, [see page 5](#))
4. Options Desired (if different than original product)

### Weatherstrip

#### Weatherstrip - Interlock (December 2007 to present)

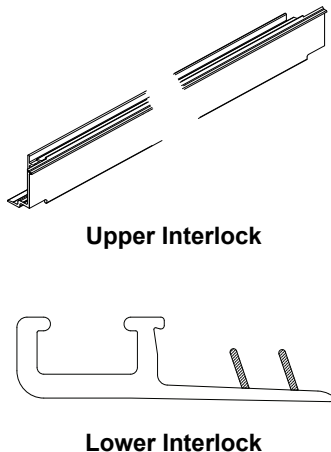

**Note:**

Upper and lower interlock weatherstrip for standard and custom size windows are made to order. Cut to Length. Also order felt spacer and screws for lower interlock. Lineal lengths are available for service replacement ([see page 31](#)).

*To order, state:*

1. Description of Part (Upper or Lower Weatherstrip Interlock)
2. Quantity
3. Product ID (from product label, [see page 5](#))

## Sash

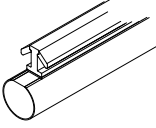
Screw - Lower Interlock			
		Description	Order No.
		PH pan 8 - 15 x 3/8 #5 302 SS	0102714
Weatherstrip - Bottom Rail			
			Length
			10 ft
			Order No.
			0102606

## Sash Hardware

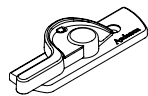
Lock			
		Finish	Order No.
	<b>Note:</b> Ships with screws.	Stone	0102006
		White	0102005

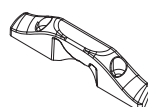
Keeper			
		Finish	Order No.
	<b>Note:</b> Ships with screws.	Stone	0102015
		White	0102014

Screw - Lock and Keeper			
		Finish	Order No.
		White	0102003
		Stone	0102004

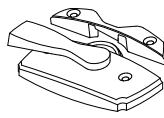
Lock Set - Estate			
		Finish	Order No.
	<b>Set includes:</b> Lock, keeper, and screws	Bright Brass	0102628
		Antique Brass	0102630
		Brushed Chrome	0102629
		Polished Chrome	0102632
		Oil Rubbed Bronze	0102631
		Satin Nickel	0102633
		Distressed Bronze	0102621
		Distressed Nickel	0102622

Hand Lift with Screws			
		Finish	Order No.
			Stone
			White
			Order No.
			1643001
			1643002

# Woodwright™ Insert Windows

Double-Hung, Picture & Transom Insert Windows

## Sash

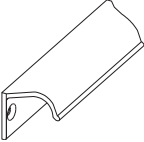
Hand Lift with Screws (Estate)			
		<b>Finish</b>	
		<b>Order No.</b>	
		Antique Brass	1600694
		Antique Brass (Chocolate Brown - 06)	1643044
		Bright Brass	1643043
		Polished Chrome	1643045
		Brushed Chrome	1600404
		Satin Nickel	1642922
		Oil Rubbed Bronze	1642921
		Distressed Bronze	1642932
	Distressed Nickel	1600405	

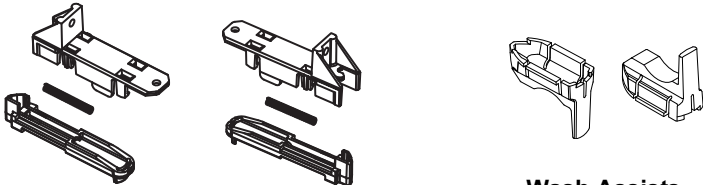
Tilt-Latch and Wash Assist Kit		
		
<div style="display: flex; justify-content: space-around;"> <div style="text-align: center;"> <p><b>Tilt-Latches</b></p> </div> <div style="text-align: center;"> <p><b>Wash Assists</b></p> </div> </div>		
	<b>Finish</b>	<b>Order No.</b>
	White	0102091
	Gray	0102092

Latch Screw	
	<b>Order No.</b>
	0102011

## Sash

### Opening Control Device Kit

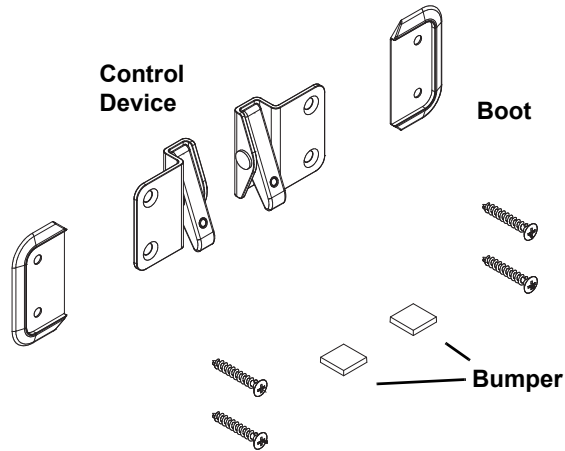

**Kit includes:**

Two opening control devices, two boots, screws, bumpers and instructions

	Finish	Order No.
	Stone	9021976
	White	9021975

### Screw - Check Rail Packaging Clip

	Description	Color	Order No.
	#8 - 10 x 1 3/16"	Stone	0873242
		White	0873241

**Note:**  
Use screw to replace packaging clip on check rail.

### Sash Keeper Spacer

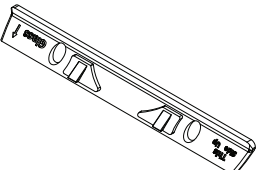
	Finish	Order No.
	Stone	0100085
	White	0100083

## Sash Balancers

### Sash Balancers

#### Sash Balancers

**Note:**

The balancer number is imprinted onto the side of each balancer. Refer to the charts below to find the proper order number.

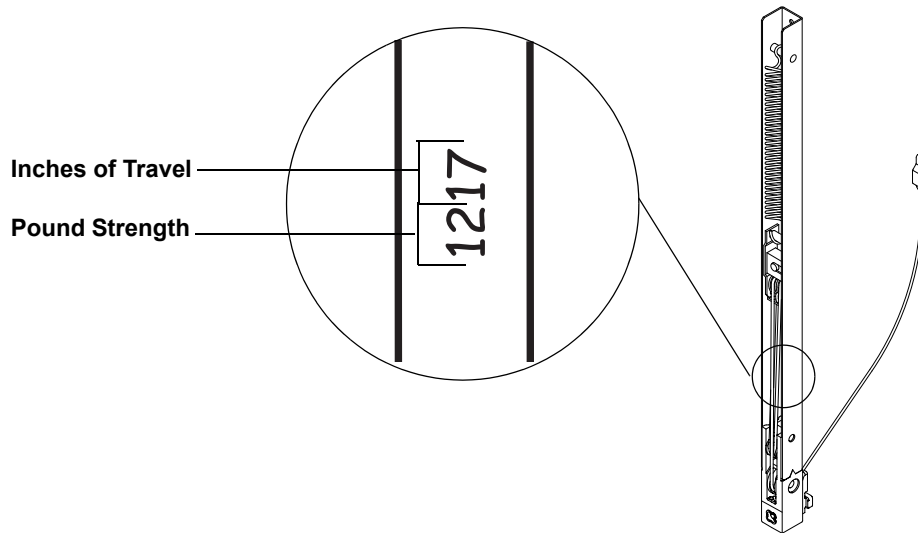

**Woodwright Insert Double-Hung Sash Balancer**

### Sash Balancers

Balancer No.	Order No.	Balancer No.	Order No.	Balancer No.	Order No.	Balancer No.	Order No.
311	0102782	519	0102807	626	0102830	727	0102853
312	0102783	520	0102808	627	0102831	728	0102854
313	0102784	521	0102809	628	0102832	729	0102855
314	0102785	522	0102810	629	0102833	730	0102856
315	0102786	523	0102811	630	0102834	731	0102857
412	0102789	524	0102812	631	0102835	732	0102858
413	0102790	526	0102813	712	0102838	733	0102859
414	0102791	613	0102817	714	0102840	734	0102860
415	0102792	614	0102818	715	0102841	735	0102861
416	0102793	615	0102819	716	0102842	736	0102862
417	0102794	616	0102820	717	0102843	812	0102865
418	0102795	617	0102821	718	0102844	815	0102868
419	0102796	618	0102822	719	0102845	816	0102869
420	0102797	619	0102823	720	0102846	817	0102870
513	0102801	620	0102824	721	0102847	818	0102871
514	0102802	621	0102825	722	0102848	819	0102872
515	0102803	622	0102826	723	0102849	820	0102873
516	0102804	623	0102827	724	0102850	821	0102874

## Sash Balancers

Sash Balancers							
Balancer No.	Order No.	Balancer No.	Order No.	Balancer No.	Order No.	Balancer No.	Order No.
517	0102805	624	0102828	725	0102851	822	0102875
518	0102806	625	0102829	726	0102852	823	0102876
824	0102877	934	0102920	1040	0102962	1145	0103003
825	0102878	935	0102921	1041	0102963	1214	0103006
826	0102879	936	0102922	1042	0102964	1217	0103009
827	0102880	937	0102923	1043	0102965	1218	0103010
828	0102881	938	0102924	1044	0102966	1219	0103011
829	0102882	939	0102925	1045	0102967	1220	0103012
830	0102883	940	0102926	1112	0102969	1221	0103013
831	0102884	941	0102927	1113	0102970	1222	0103014
832	0102885	942	0102928	1114	0102971	1223	0103015
833	0102886	943	0102929	1116	0102973	1224	0103016
834	0102887	944	0102930	1117	0102974	1225	0103017
835	0102888	945	0102931	1118	0102975	1226	0103018
836	0102889	1012	0102934	1119	0102976	1227	0103019
837	0102890	1013	0102935	1120	0102977	1228	0103020
838	0102891	1016	0102938	1121	0102978	1229	0103021
839	0102892	1017	0102939	1122	0102979	1230	0103022
840	0102893	1018	0102940	1123	0102980	1231	0103023
841	0102894	1019	0102941	1124	0102981	1232	0103024
912	0102897	1020	0102942	1125	0102982	1233	0103025
915	0102901	1021	0102943	1126	0102983	1234	0103026
916	0102902	1022	0102944	1127	0102984	1235	0103027
917	0102903	1023	0102945	1128	0102985	1236	0103028
918	0102904	1024	0102946	1129	0102986	1237	0103029
919	0102905	1025	0102947	1130	0102987	1238	0103030
920	0102906	1026	0102948	1131	0102988	1239	0103031
921	0102907	1027	0102949	1132	0102989	1240	0103032
922	0102908	1028	0102950	1133	0102990	1241	0103033
923	0102909	1029	0102951	1134	0102991	1242	0103034
924	0102910	1030	0102952	1135	0102992	1243	0103035
925	0102911	1031	0102953	1136	0102993	1244	0103036
926	0102912	1032	0102954	1137	0102994	1245	0103037
927	0102913	1033	0102955	1138	0102995	1318	0103042
928	0102914	1034	0102956	1139	0102996	1319	0103043
929	0102915	1035	0102957	1140	0102997	1320	0103044
930	0102916	1036	0102958	1141	0102998	1321	0103045
931	0102917	1037	0102959	1142	0102999	1322	0103046
932	0102918	1038	0102960	1143	0103001	1323	0103047
933	0102919	1039	0102961	1144	0103002	1324	0103048

## Sash Balancers

Sash Balancers							
Balancer No.	Order No.	Balancer No.	Order No.	Balancer No.	Order No.	Balancer No.	Order No.
1325	0103049	1437	0103091	1625	0103138	1739	0103179
1326	0103050	1438	0103092	1626	0103139	1740	0103180
1327	0103051	1439	0103093	1627	0103140	1741	0103181
1328	0103052	1440	0103094	1628	0103141	1742	0103182
1329	0103053	1441	0103095	1629	0103142	1743	0103183
1330	0103054	1442	0103096	1630	0103143	1744	0103184
1331	0103055	1443	0103097	1631	0103144	1745	0103185
1332	0103056	1444	0103098	1632	0103145	1825	0103190
1333	0103057	1445	0103099	1633	0103146	1826	0103191
1334	0103058	1520	0103104	1634	0103147	1827	0103192
1335	0103059	1521	0103105	1635	0103148	1828	0103193
1336	0103060	1522	0103106	1636	0103149	1829	0103194
1337	0103061	1523	0103107	1637	0103150	1830	0103195
1338	0103062	1524	0103108	1638	0103151	1831	0103196
1339	0103063	1525	0103109	1639	0103152	1832	0103197
1340	0103064	1526	0103110	1640	0103153	1833	0103198
1341	0103065	1527	0103111	1641	0103154	1834	0103199
1342	0103066	1528	0103112	1642	0103155	1835	0103201
1343	0103067	1529	0103113	1643	0103156	1836	0103202
1344	0103068	1530	0103114	1644	0103157	1837	0103203
1345	0103069	1531	0103115	1645	0103158	1838	0103204
1420	0103074	1532	0103116	1722	0103162	1839	0103205
1421	0103075	1533	0103117	1723	0103163	1840	0103206
1422	0103076	1534	0103118	1724	0103164	1841	0103207
1423	0103077	1535	0103119	1725	0103165	1842	0103208
1424	0103078	1536	0103120	1726	0103166	1843	0103209
1425	0103079	1537	0103121	1727	0103167	1844	0103210
1426	0103080	1538	0103122	1728	0103168	1845	0103211
1427	0103081	1539	0103123	1729	0103169	1925	0103215
1428	0103082	1540	0103124	1730	0103170	1926	0103216
1429	0103083	1541	0103125	1731	0103171	1927	0103217
1430	0103084	1542	0103126	1732	0103172	1928	0103218
1431	0103085	1543	0103127	1733	0103173	1929	0103219
1432	0103086	1544	0103128	1734	0103174	1930	0103220
1433	0103087	1545	0103129	1735	0103175	1931	0103221
1434	0103088	1622	0103135	1736	0103176	1932	0103222
1435	0103089	1623	0103136	1737	0103177	1933	0103223
1436	0103090	1624	0103137	1738	0103178	1934	0103224

## Sash Balancers

Sash Balancers							
Balancer No.	Order No.	Balancer No.	Order No.	Balancer No.	Order No.	Balancer No.	Order No.
1935	0103225	1939	0103229	1943	0103234	2026	0103238
1936	0103226	1940	0103231	1945	0103235	2027	0103239
1937	0103227	1941	0103232	2024	0103236	2028	0103240
1938	0103228	1942	0103233	2025	0103237	2029	0103241

### Sash Balancer Hardware

#### Screw - Balance Hole / Bottom

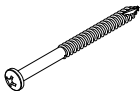
	Description	Order No.
	8 - 18 x 2 PH #6 pan HD YMZC T-17 T/C	0102625

#### Screw - Balance Hole / Top

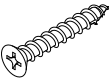
	Description	Order No.
	8 - 10 x 1-3/16 PH flat HD plask #2 w/shank slot	0102624

#### Screw - Shoulder

	Description	Package of 2
	#8 x 5/8"	0112045

#### Balancer Clip *(May 2009 to Present)*

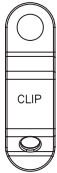
	Note:	Order No.
	Balance cord clip attaches to side jamb.	9019790

#### Screw - Balancer Clip *(May 2009 to Present)*

	Description	Order No.
	8 - 15 x 5/8 Cross Recess #6 Truss HD Type 17 <b>Note:</b> Used to secure balance cord clip to side jamb.	1351338

#### Screw - Balancer Clip *(December 2007 to April 2009)*

	Description	Order No.
	8 - 15 x 5/8 #10 pan HD type 17 <b>Note:</b> Used to secure balance cord clip to side jamb.	9000915

### Glass - Picture and Transom Units

#### Glass - Picture and Transom Units

**Note:**

Picture and transom window glass is made to order.

*To order, state:*

1. **Description of part (picture or transom window glass)**
2. **Quantity**
3. **Product ID (from product label, [see page 5](#))**

## Insect Screens

### Insect Screen - Full

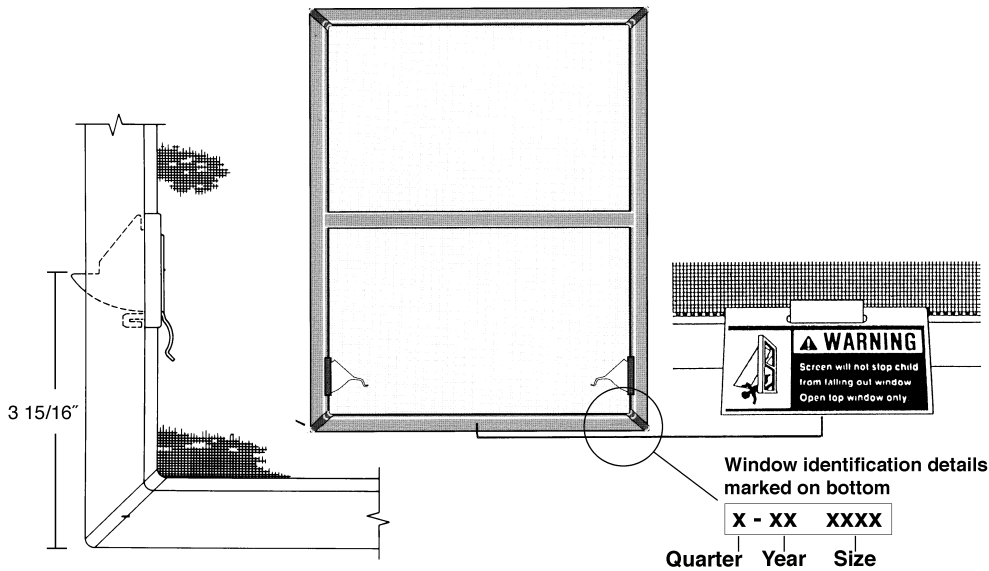

Woodwright Insert Window Full Insect Screen

### Insect Screen - Full / TruScene™

**Note:**

Full window insect screens with TruScene screens are made to order.

To order, state:

1. Description of Part (full insect screen with TruScene screen)
2. Quantity
3. Product ID (from product label, [see page 5](#))

### Insect Screen - Full / Standard

**Note:**

Full window insect screens with standard screens are made to order.

To order, state:

1. Description of Part (full insect screen with standard screen)
2. Quantity
3. Product ID (from product label, [see page 5](#))

### Insect Screen - Half

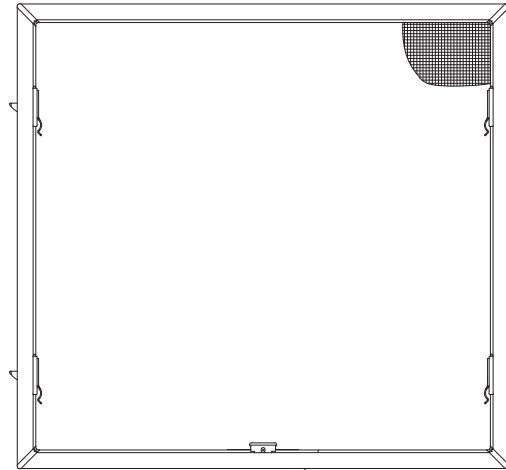

**Woodwright Insert Window Half Insect Screen**

### Insect Screen - Half / TruScene™

**Note:**

TruScene half insect screen replacements are made to order.

*To order, state:*

1. **Description of Part (TruScene half screen)**
2. **Quantity**
3. **Product ID (from product label, [see page 5](#))**

### Insect Screen - Half / Standard

**Note:**

Standard half insect screen replacements are made to order.

*To order, state:*

1. **Description of Part (standard half screen)**
2. **Quantity**
3. **Product ID (from product label, [see page 5](#))**

## Insect Screens

### Screen Parts

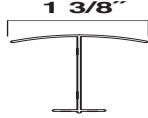
Screen Lock with Housing (Pair)			
		Color	Order No.
		Stone	By description
		White	By description

### Bug Seal

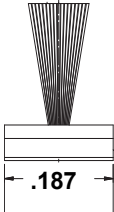
	<b>Note:</b> Order by the foot. Replacement weatherstrip/bug seal is adhesive backed.	Order No.
		8261001

## Grilles

### Interior Grilles

Interior Grilles - Removable	
	<p><b>Note:</b> Removable interior grilles are made to order.</p> <p><i>To order, state:</i></p> <ol style="list-style-type: none"> <li><b>Description of Part (removable interior grilles)</b></li> <li><b>Quantity</b></li> <li><b>Product ID (from product label, <a href="#">see page 5</a>)</b></li> </ol>

Interior Grilles - Finelight / High-Definition / Exterior
<p><b>Note:</b> Replacement finelight grilles, high-definition grilles, and exterior grilles are available as part of a replacement sash only. To order, see upper and lower sash, <a href="#">page 7</a>.</p>

Interior Grille Clips			
	<p><b>Note:</b> Clip affixes to sash.</p>	<b>Finish</b>	<b>Package of 12</b>
		White	0174951
		Terratone	0174952
		Sandtone	0174953
		Forest Green	0174955

## Grilles

### Exterior Grilles - HDN

#### Exterior Grille - HDN / Lineal / PVC

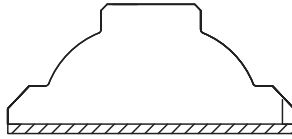

Length	White			Terratone			Sandtone		
	3/4"	7/8"	1 1/8"	3/4"	7/8"	1 1/8"	3/4"	7/8"	1 1/8"
60 in	2322030	2322034	2322038	2322101	2322103	2322105	2322032	2322036	2322040
84 in	2322031	2322035	2322039	2322102	2322104	2322106	2322033	2322037	2322041

## Frames

Complete Frames	
Complete Frames	
	<p><b>Note:</b> Complete frames for double-hung, picture, and transom insert windows are made to order.</p> <p><i>To order, state:</i></p> <ol style="list-style-type: none"> <li>1. Description of Part (complete frame)</li> <li>2. Quantity</li> <li>3. Product ID (from product label, <a href="#">see page 5</a>)</li> </ol>

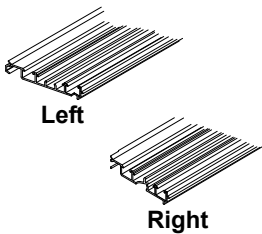
Jamb Liner - Side	
 <p>Left</p> <p>Right</p>	<p><b>Note:</b> Side jamb liners are made to order.</p> <p><b>Kit includes:</b> Left and right hand liners and components.</p> <p><i>To order, state:</i></p> <ol style="list-style-type: none"> <li>1. Description of Part (side jamb liner)</li> <li>2. Quantity</li> <li>3. Product ID (from product label, <a href="#">see page 5</a>)</li> </ol>

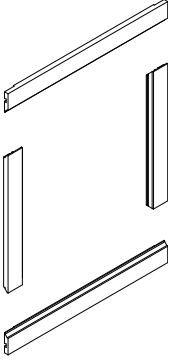
Stops	
Inside Stop Kit - Double-Hung Units	
	<p><b>Note:</b> Inside stops are made to order. Available in kit only.</p> <p><b>Kit includes:</b> Head, sill, right hand, and left hand side stops.</p> <p><i>To order, state:</i></p> <ol style="list-style-type: none"> <li>1. Description of Part (inside stop kit)</li> <li>2. Quantity</li> <li>3. Product ID (from product label, <a href="#">see page 5</a>)</li> </ol>

## Frames

### Glass Stop Kit - Picture and Transom Units / Side

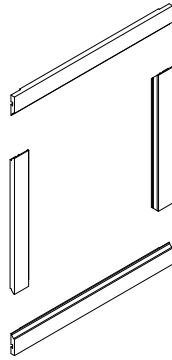
	<p><b>Note:</b> Side glass stops are made to order. Available in kit only.</p> <p><b>Kit includes:</b> Head, sill, right hand and left hand glass stops. Does not include glass clips for stop attachment.</p> <p><i>To order state:</i></p> <ol style="list-style-type: none"> <li><b>Description of Part (side glass stop kit)</b></li> <li><b>Quantity</b></li> <li><b>Product ID (from product label, <a href="#">see page 5</a>)</b></li> </ol>
---	--

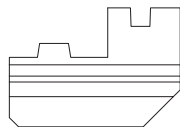

### Inside Stop Kit - Picture and Transom Units

	<p><b>Note:</b> Inside stops are made to order. Available in kit only.</p> <p><b>Kit includes:</b> Head, sill, right hand, and left hand side stops.</p> <p><i>To order, state:</i></p> <ol style="list-style-type: none"> <li><b>Description of Part (inside stop kit)</b></li> <li><b>Quantity</b></li> <li><b>Product ID (from product label, <a href="#">see page 5</a>)</b></li> </ol>
---	---

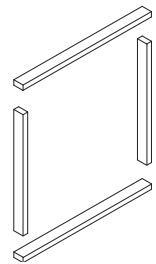

## Filler Kit

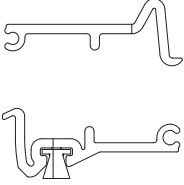
### Filler Kit - Picture and Transom Units / Head and Sill

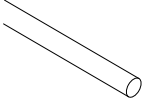
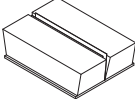
	<p><b>Note:</b> Filler kits are made to order.</p> <p><b>Kit includes:</b> Head, sill, right-hand and left-hand fillers.</p> <p><i>To order state:</i></p> <ol style="list-style-type: none"> <li><b>Description of Part (head and sill filler kit)</b></li> <li><b>Quantity</b></li> <li><b>Product ID (from product label, <a href="#">see page 5</a>)</b></li> </ol>	<b>Length</b>	<b>Finish</b>	<b>Order No.</b>
		75	Pine	0102712
			Maple	0102724
			Oak	0102723
			Prefinished White	0102722

Weatherstrip - Double-Hung Units							
Weatherstrip - Lower and Upper Side Jamb							
	<p><b>Note:</b> Lower and upper side jamb weatherstrip for standard and custom size windows are made to order. Upper weatherstrip has no felt weatherstrip; lower weatherstrip has felt weatherstrip applied (after 11/06).</p> <p><i>To order, state:</i></p> <ol style="list-style-type: none"> <li><b>1. Description of Part (Lower side jamb weatherstrip)</b></li> <li><b>2. Quantity</b></li> <li><b>3. Product ID (from product label, <a href="#">see page 5</a>)</b></li> </ol>						
Weatherstrip - Fin-Pile							
	<p><b>Note;</b> Used on lower side jamb assembly.</p>	<table border="1"> <thead> <tr> <th>Length</th> <th>Order No.</th> </tr> </thead> <tbody> <tr> <td>Order by the foot</td> <td>9056123</td> </tr> </tbody> </table>	Length	Order No.	Order by the foot	9056123	
Length	Order No.						
Order by the foot	9056123						
Weatherstrip - Bottom Rail / Solid							
		<table border="1"> <thead> <tr> <th>Length</th> <th>Order No.</th> </tr> </thead> <tbody> <tr> <td>10 ft</td> <td>0102612</td> </tr> </tbody> </table>	Length	Order No.	10 ft	0102612	
Length	Order No.						
10 ft	0102612						
Weatherstrip - Dust Plug							
			<table border="1"> <thead> <tr> <th>Order No.</th> </tr> </thead> <tbody> <tr> <td>0102623</td> </tr> </tbody> </table>	Order No.	0102623		
Order No.							
0102623							

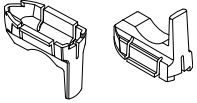
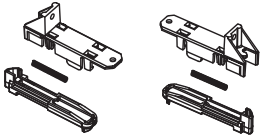
## Frames

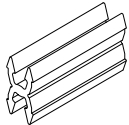
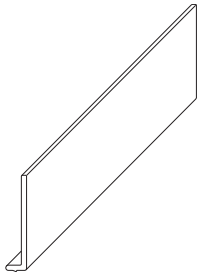
Frame Parts				
Tilt-Latch and Wash Assist Kit				
 <p><b>Wash Assists</b></p>  <p><b>Tilt-Latches</b></p>	<b>Kit includes:</b> Two tilt-latches, two wash assists, and instruction guide	<b>Finish</b>		<b>Order No.</b>
		White		0102091
		Gray		0102092
Latch Screw				
				<b>Order No.</b>
				0102011
Limited Travel Bumper				
	<b>Note:</b> Use to replace all previous vintage bumpers. Also order screws, 0112045. Both come as a package of two.			<b>Package of 2</b>
				0112044
Glass Clip (Klick Fastener) - Picture and Transom Units				
				<b>Order No.</b>
				0102080
Exterior Trim Stop Cover				
<b>Note:</b> Exterior stop cover snaps into outside frame member creating a finished look between the insert window and the existing exterior window trim. Available as single pieces or a package of 20. Cut trim stop cover to desired width.				
	<b>Length</b>	<b>Finish</b>	<b>Single Piece</b>	<b>Package of 20</b>
	12 ft	White	0112072	0112029
		Terratone	0112074	0112031
		Sandtone	0112073	0112030
		Forest Green	0112075	0112032

# Woodwright™ Insert Windows

Double-Hung, Picture & Transom Insert Windows

## Frames

Bumpers		
	Finish	Order No.
	White	9019610
	Stone	9019611

Rods		
	Finish	Order No.
	White	9019606
	Stone	9019608

## Joining Components

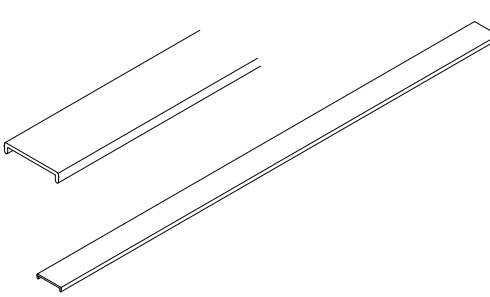
Narrow Joining Parts			
Trim Strip - Exterior Mull			
	Length	Finish	Order No.
	4 ft	White	1292078
		Terratone	1292080
		Sandtone	1292079
		Forest Green	1292081
	7 ft	White	0112052
		Terratone	0112054
		Sandtone	0112053
		Forest Green	0112055
	12 ft	White	1292178
		Terratone	1292180
		Sandtone	1292179
		Forest Green	1292181
Joining Hardware Kit			
	<b>Kit includes:</b> 2 joining brackets, 22 joining screws, and a joining installation guide	<b>Order No.</b> 0102022	
Joining Brackets (Pair)			
	<b>Note:</b> Brackets are included in joining hardware kit above.	<b>Order No.</b> N/A	
Joining Screw			
	<b>Description</b> 8 x 1 1/8"	<b>Order No.</b> 0112077	
	<b>Note:</b> Sold individually. 22 screws are required per join. Screws are included in joining hardware kit above.		

Casing - Interior Mull				
	Length	Finish	Single Piece	Package of 20
	6 ft	Pine	1611557	0112056
		Maple	0102593	0112057
		Oak	0102591	0112058
		Prefinished White	0102595	0112059
	8 ft	Pine	0112060	0112064
		Maple	0102594	0112061
		Oak	0102592	0112062
Prefinished White		0102596	0112063	

## Joining Components

### Universal Drip Cap - Continuous

**Note:**

Use on side-by-side or vertical joins mullled at the factory or distributor. Consists of 24 gauge aluminum material.

<b>Drip Cap - Continuous - 72"</b>				
<b>Qty in Package</b>	<b>White</b>	<b>Terratone</b>	<b>Sandtone</b>	<b>Forest Green</b>
1	2222525	2222528	2222530	2222532
10	2222526	2222529	2222531	2222533
40	2222527	N/A	N/A	N/A
<b>Drip Cap - Continuous - 120"</b>				
<b>Qty in Package</b>	<b>White</b>	<b>Terratone</b>	<b>Sandtone</b>	<b>Forest Green</b>
1	2222546	2222549	2222551	2222553
10	2222547	2222550	2222552	2222554
40	2222548	N/A	N/A	N/A
<b>Drip Cap - Continuous - 151 1/2"</b>				
<b>Qty in Package</b>	<b>White</b>	<b>Terratone</b>	<b>Sandtone</b>	<b>Forest Green</b>
1	2222555	2222557	2222559	2222561
10	2222556	2222558	2222560	2222562

## Installation Materials

### Installation Materials

Installation Kit - Double-Hung Units			
	<b>Note:</b> One kit is shipped with each double-hung insert window.  <b>Kit includes:</b> Installation screws, 40 installation shims (1/16" thick, quantity 32; 1/32" thick, quantity 8), 3/8" diameter backer rod	<b>Order No.</b>	
		0112046	
Installation Kit - Picture and Transom Units			
	<b>Note:</b> One kit is shipped with each picture or transom insert window.  <b>Kit includes:</b> Installation screws, 56 installation shims (1/16" thick, quantity 40; 1/32" thick, quantity 16), 3/8" diameter backer rod	<b>Order No.</b>	
		0102021	
Installation Shim Insert			
		<b>Case of 2000</b>	
		<b>1/16"</b>	<b>1/32"</b>
		0112081	0112082
Installation Screw - Double-Hung Units			
	<b>Description</b>		<b>Order No.</b>
	#8 x 2" panhead		
	<b>Note:</b> Used to attach insert frame to existing opening.		0112047

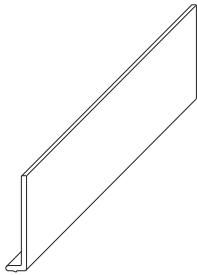
Exterior Trim Stop Cover				
<b>Note:</b> Exterior stop cover snaps into outside frame member creating a finished look between the insert window and the existing exterior window trim. Available as single pieces or a package of 20. Cut trim stop cover to desired width.				
	<b>Length</b>  12 ft	<b>Finish</b>	<b>Single Piece</b>	<b>Package of 20</b>
		White	0112072	0112029
		Terratone	0112074	0112031
		Sandtone	0112073	0112030
		Forest Green	0112075	0112032

## Installation Materials

### Stops - Interior

**Note:**

The interior stop can be ripped to desired width. Rip down center of part to obtain two stops approximately 1-1/4" wide. Interior stop profile is reversible after ripping. Use the milled profile to complement Woodwright insert window sash profile or use reverse side with square edge to trim interior of window.

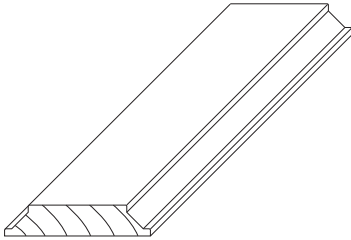

Dimensions (w x l)	Finish	Single	Box of 6
2 21/32 x 48	Pine	0112021	0112121
	Maple	0112022	0112122
	Oak	0112023	0112123
	Prefinished White	0112024	0112124
2 21/32 x 84	Pine	0112025	0112125
	Maple	0112026	0112126
	Oak	0112027	0112127
	Prefinished White	0112028	0112128

## Installation Materials

---

#### Sash Interlocks - Upper and Lower

**Note:**

Specific size upper interlocks made to order. 51-1/2" length interlock can be cut to size, if desired.

To order, state:

1. Description of Part (upper sash interlock or lower sash interlock)
2. Quantity
3. Product ID (from product label, [see page 5](#))

#### Sash Interlock - Upper

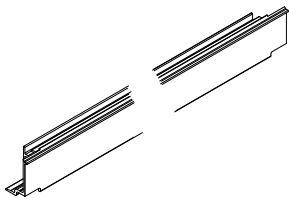

#### Sash Interlock - Lower (December 2007 to present)

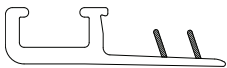

**Note:**

Cut to Length. Also order felt spacer and screws.

**Length**

51 1/2

**Order No.**

0102016

#### Screw - Lower Interlock

**Description**

PH pan 8 - 15 x 3/8 #5 302 SS

**Order No.**

0102714

#### Sash Lock Spacer



**Finish**

Stone

White

**Order No.**

0100084

0100082

#### Sash Spacer - Felt / Lower Sash Check Rail

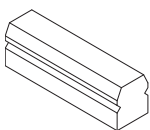

**Note:**

Use on lower sash check rail weatherstrip.

**Order No.**

0102780

## Service Replacement Only

### Service Materials

#### VHB Tape

	Dimensions	Order No.
	1/4 x 10 ft	0102627

#### Weatherstrip - Interlock Clash

	<b>Note:</b> Weatherstrip is 1 1/4" wide with an adhesive back	Color	Order No.
		White	2855171
		Gray	2855137

#### Silicone Sealant - DC891

	Size	Color	Order No.
	10.3 oz	White	2902621
		Sandtone	2902623
		Terratone	2902622

### Jamb Liners

#### Liner Plug - Side / Sill

	Order No.
	0102708

## Service Replacement Only

Jamb Liner - Head	
	<p><b>Note:</b> Head jamb liners are made to order.</p> <p><i>To order, state:</i></p> <ol style="list-style-type: none"> <li><b>Description of Part (head jamb liner)</b></li> <li><b>Quantity</b></li> <li><b>Product ID (from product label, <a href="#">see page 5</a>)</b></li> </ol>

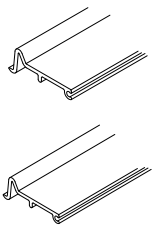
Weatherstrip - Double-Hung Units				
Weatherstrip - Lower Side Jamb				
	<p><b>Note:</b> Cut to length.</p>	<b>Length</b>	<b>Finish</b>	<b>Order No.</b>
		48	White/Pine	0102721
			Gray/Pine	0102711

**Notes**

---