

**What's in This Section**

**Note:**  
SK Units use SKS flashing (page 9) and pleated shades (page 14) for replacement.

**Snap Fit Skylight (SKS) Windows (1999 to 2009) . . . . . Page 3**

- Parts Illustration . . . . . 3**
- Unit Sizes . . . . . 4**
- Sash . . . . . 5**
  - Glass Size Table . . . . . 5
  - Sash and Frame Assembly . . . . . 6
  - Sash . . . . . 6
  - Sash Parts . . . . . 7
- Frames . . . . . 8**
  - Frames . . . . . 8
  - Frame Parts . . . . . 8
- Flashing . . . . . 9**
  - Flashing . . . . . 9
  - Water Deflector . . . . . 13
- Shades . . . . . 14**
  - Shades . . . . . 14
  - Shade Parts . . . . . 15

**Skylight (SK) Units (1991 to 1999) . . . . . Page 17**

- Parts Illustration . . . . . 17**
- Unit Sizes . . . . . 18**
- Sash . . . . . 19**
  - Glass Size Table . . . . . 19
  - Sash and Frame Assembly . . . . . 20
  - Sash . . . . . 21
- Frames . . . . . 23**
  - Frames . . . . . 23
  - Frame Gasket . . . . . 23

**Stormwatch™ Protection (Coastal Product) . . . . . Page 25**

- Sash . . . . . 25**
  - Sash . . . . . 25



# Skylight (SKS) and Skylight (SK) Windows (1991 to 2009)

## Snap Fit Skylight (SKS) Windows (1999 to 2009)

### Parts Illustration

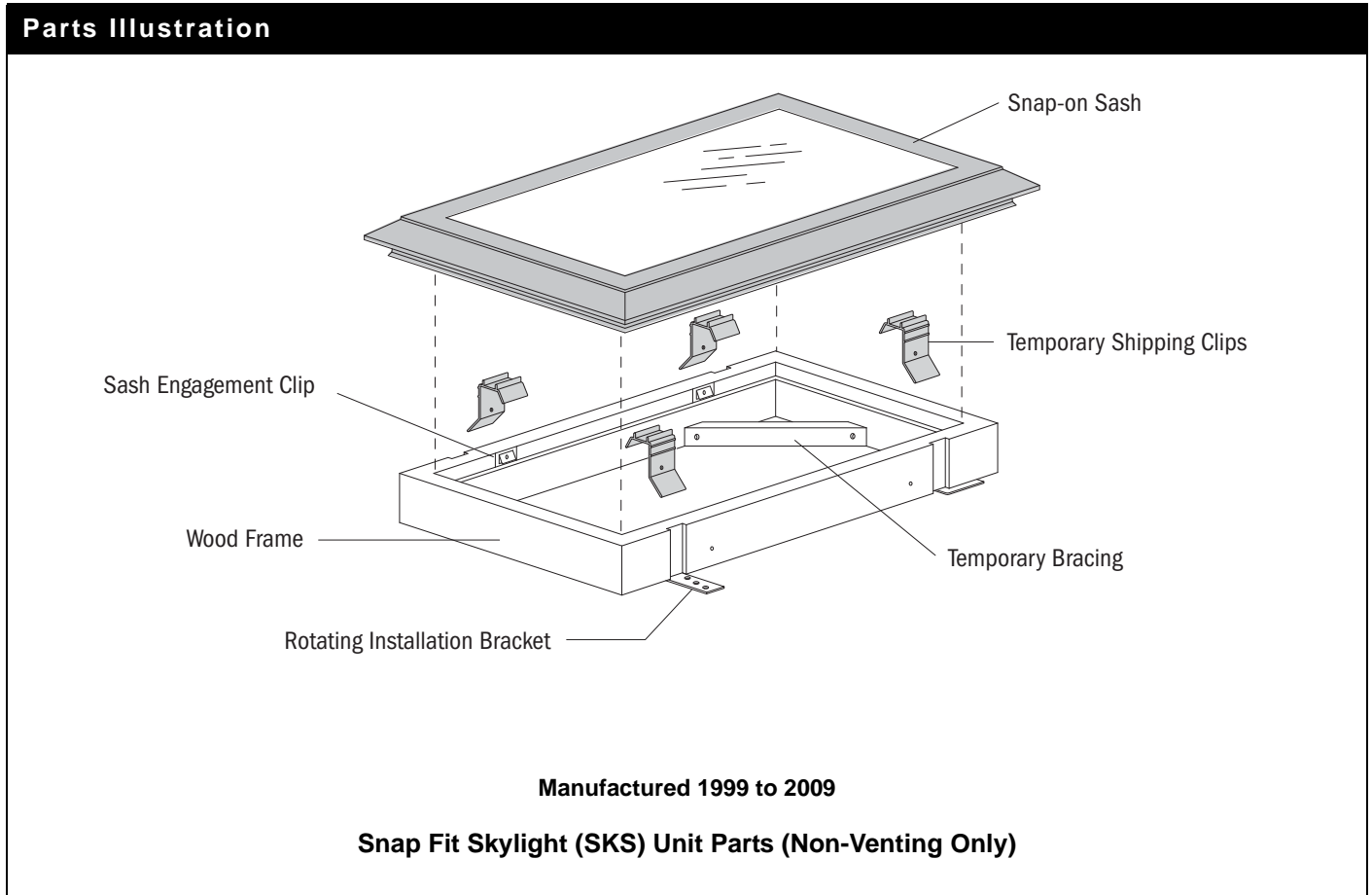

*Unit viewed from exterior.*

## Unit Sizes

### Unit Size Chart

**Note:**

Unit Dimension refers to overall outside-to-outside frame. Unobstructed Glass refers to visible glass dimensions. Numbers in parentheses are metric measurements.

Unit Dimensions	16 1/2"	24 1/2"	28"	44"	Unit Dimensions	27"	38"	46"	57"	72"
	(419)	(622)	(711)	(1118)		(686)	(965)	(1168)	(1448)	(1829)
<b>Rough Opening</b>	14 1/2"	22 1/2"	26"	42"	<b>Rough Opening</b>	25"	36"	44"	55"	70"
	(368)	(572)	(660)	(1067)		(635)	(914)	(1118)	(1397)	(1778)
<b>Rough Opening using straight brackets</b>	17"	25"	28 1/2"	44 1/2"	<b>Rough Opening using straight brackets</b>	27 1/2"	38 1/2"	46 1/2"	57 1/2"	72 1/2"
	(432)	(635)	(724)	(1130)		(699)	(978)	(1181)	(1461)	(1842)
<b>Unobstructed Glass</b>	14"	22"	25 1/2"	41 1/2"	<b>Unobstructed Glass</b>	24 1/2"	35 1/2"	43 1/2"	54 1/2"	69 1/2"
	(356)	(559)	(648)	(1054)		(622)	(902)	(1105)	(1384)	(1765)

27"	25"	24 1/2"	28"	44"	16 1/2"	27"	38"	46"	57"	72"
(686)	(635)	(622)	(711)	(1118)	(419)	(686)	(965)	(1168)	(1448)	(1829)
SKS 1638	SKS 1646	SKS 2427	SKS 2438	SKS 2838	SKS 2724	SKS 3816	SKS 3824	SKS 4616	SKS 4624	SKS 5724
SKS 2472	SKS 2486	SKS 2846	SKS 4446	SKS 4446	SKS 3828	SKS 4628	SKS 5728	SKS 7228	SKS 7228	SKS 4644
SKS 2457	SKS 2857	SKS 2472	SKS 2872							

### Snap Fit Skylight (SKS) Unit Sizes

Unit viewed from exterior.

# Skylight (SKS) and Skylight (SK) Windows (1991 to 2009)

*Snap Fit Skylight (SKS) Windows (1999 to 2009)*

## Sash

### Glass Size Table

**Note:**

SKS units are available in custom sizes from 16" wide to 27" high to 44" wide by 72" high. Order replacement parts for these windows by description.

### Glass Size Table

Unit No.	Actual Sash	Unobstructed Glass (w x h)	Actual Glass (w x h)	Unit No.	Actual Sash	Unobstructed Glass (w x h)	Actual Glass (w x h)
<b>SKS 1638</b>	18 <sup>11</sup> / <sub>16</sub> × 40 <sup>3</sup> / <sub>16</sub>	14 × 35 <sup>1</sup> / <sub>2</sub>	15 <sup>11</sup> / <sub>16</sub> × 37 <sup>3</sup> / <sub>16</sub>	<b>SKS 2472</b>	26 <sup>11</sup> / <sub>16</sub> × 74 <sup>3</sup> / <sub>16</sub>	22 × 69 <sup>1</sup> / <sub>2</sub>	23 <sup>11</sup> / <sub>16</sub> × 71 <sup>3</sup> / <sub>16</sub>
<b>SKS 1646</b>	18 <sup>11</sup> / <sub>16</sub> × 48 <sup>3</sup> / <sub>16</sub>	14 × 43 <sup>1</sup> / <sub>2</sub>	15 <sup>11</sup> / <sub>16</sub> × 45 <sup>3</sup> / <sub>16</sub>	<b>SKS 2838</b>	30 <sup>11</sup> / <sub>16</sub> × 40 <sup>3</sup> / <sub>16</sub>	25 <sup>1</sup> / <sub>2</sub> × 35 <sup>1</sup> / <sub>2</sub>	27 <sup>3</sup> / <sub>16</sub> × 37 <sup>3</sup> / <sub>16</sub>
<b>SKS 2427</b>	26 <sup>11</sup> / <sub>16</sub> × 29 <sup>3</sup> / <sub>16</sub>	22 × 24 <sup>1</sup> / <sub>2</sub>	23 <sup>11</sup> / <sub>16</sub> × 26 <sup>3</sup> / <sub>16</sub>	<b>SKS 2846</b>	30 <sup>11</sup> / <sub>16</sub> × 48 <sup>3</sup> / <sub>16</sub>	25 <sup>1</sup> / <sub>2</sub> × 43 <sup>1</sup> / <sub>2</sub>	27 <sup>3</sup> / <sub>16</sub> × 45 <sup>3</sup> / <sub>16</sub>
<b>SKS 2438</b>	26 <sup>11</sup> / <sub>16</sub> × 40 <sup>3</sup> / <sub>16</sub>	22 × 35 <sup>1</sup> / <sub>2</sub>	23 <sup>11</sup> / <sub>16</sub> × 37 <sup>3</sup> / <sub>16</sub>	<b>SKS 2857</b>	30 <sup>11</sup> / <sub>16</sub> × 59 <sup>3</sup> / <sub>16</sub>	25 <sup>1</sup> / <sub>2</sub> × 54 <sup>1</sup> / <sub>2</sub>	27 <sup>3</sup> / <sub>16</sub> × 56 <sup>3</sup> / <sub>16</sub>
<b>SKS 2446</b>	26 <sup>11</sup> / <sub>16</sub> × 48 <sup>3</sup> / <sub>16</sub>	22 × 43 <sup>1</sup> / <sub>2</sub>	23 <sup>11</sup> / <sub>16</sub> × 45 <sup>3</sup> / <sub>16</sub>	<b>SKS 2872</b>	30 <sup>11</sup> / <sub>16</sub> × 74 <sup>3</sup> / <sub>16</sub>	25 <sup>1</sup> / <sub>2</sub> × 69 <sup>1</sup> / <sub>2</sub>	27 <sup>3</sup> / <sub>16</sub> × 71 <sup>3</sup> / <sub>16</sub>
<b>SKS 2457</b>	26 <sup>11</sup> / <sub>16</sub> × 59 <sup>3</sup> / <sub>16</sub>	22 × 54 <sup>1</sup> / <sub>2</sub>	23 <sup>11</sup> / <sub>16</sub> × 56 <sup>3</sup> / <sub>16</sub>	<b>SKS 4446</b>	46 <sup>11</sup> / <sub>16</sub> × 48 <sup>3</sup> / <sub>16</sub>	41 <sup>1</sup> / <sub>2</sub> × 43 <sup>1</sup> / <sub>2</sub>	43 <sup>3</sup> / <sub>16</sub> × 45 <sup>3</sup> / <sub>16</sub>

## Sash

### Sash and Frame Assembly

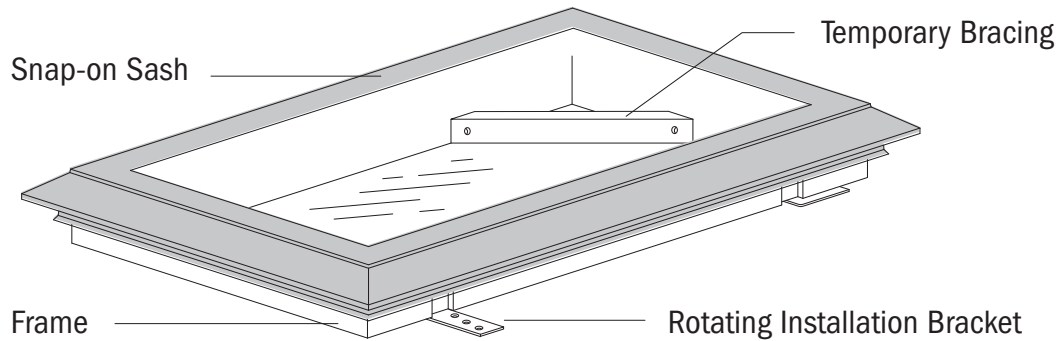

**Skylight Sash and Frame Assembly**

### Sash

**Note:**

Sash for unit size SK4457/5744 is available for Skylight (SK) units manufactured 1991 to 1999. See page 17.

#### Sash - High-Performance Tempered

Unit No.	Terratone	Unit No.	Terratone	Unit No.	Terratone
SKS 1638/3816	1880401	SKS 2446/4624	1880405	SKS 2846/4628	1880409
SKS 1646/4616	1880402	SKS 2457/5724	1880406	SKS 2857/5728	1880410
SKS 2427/2724	1880403	SKS 2472/7224	1880407	SKS 2872/7228	1880411
SKS 2438/3824	1880404	SKS 2838/3828	1880408	SKS 4446/4644	1880412

#### Sash - High-Performance Sun 3 Tempered

Unit No.	Terratone	Unit No.	Terratone	Unit No.	Terratone
SKS 1638/3816	1880413	SKS 2446/4624	1880417	SKS 2846/4628	1880421
SKS 1646/4616	1880414	SKS 2457/5724	1880418	SKS 2857/5728	1880422
SKS 2427/2724	1880415	SKS 2472/7224	1880419	SKS 2872/7228	1880423
SKS 2438/3824	1880416	SKS 2838/3828	1880420	SKS 4446/4644	1880424

#### Sash - High-Performance Sun II Tempered

Unit No.	Terratone	Unit No.	Terratone	Unit No.	Terratone
SKS 1638/3816	OBD	SKS 2446/4624	OBD	SKS 2846/4628	9005576
SKS 1646/4616	OBD	SKS 2457/5724	OBD	SKS 2857/5728	9005583
SKS 2427/2724	OBD	SKS 2472/7224	OBD	SKS 2872/7228	OBD
SKS 2438/3824	9005549	SKS 2838/3828	OBD	SKS 4446/4644	OBD

# Skylight (SKS) and Skylight (SK) Windows (1991 to 2009)

*Snap Fit Skylight (SKS) Windows (1999 to 2009)*

## Sash

Sash - High-Performance Tempered Laminated					
Unit No.	Terratone	Unit No.	Terratone	Unit No.	Terratone
SKS 1638/3816	1880425	SKS 2446/4624	1880429	SKS 2846/4628	1880433
SKS 1646/4616	1880426	SKS 2457/5724	1880430	SKS 2857/5728	1880434
SKS 2427/2724	1880427	SKS 2472/7224	1880431	SKS 2872/7228	1880435
SKS 2438/3824	1880428	SKS 2838/3828	1880432	SKS 4446/4644	1880436

Sash - High-Performance Sun 3 Tempered Laminated					
Unit No.	Terratone	Unit No.	Terratone	Unit No.	Terratone
SKS 1638/3816	1880437	SKS 2446/4624	1880441	SKS 2846/4628	1880445
SKS 1646/4616	1880438	SKS 2457/5724	1880442	SKS 2857/5728	1880446
SKS 2427/2724	1880439	SKS 2472/7224	1880443	SKS 2872/7228	1880447
SKS 2438/3824	1880440	SKS 2838/3828	1880444	SKS 4446/4644	1880448

Sash - High-Performance Sun II Tempered Laminated	
<b>Note:</b> Available by description.	

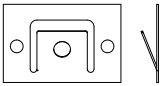
Sash Parts				
Spring Clip				
		Unit No.	Quantity Used	Order No.
		1638,1646, 2427, 2438, 2838	4	1880462
		2446, 2457, 2472, 2846, 2857, 2872	6	
	4446	8		
Hole Plug - Spring Clip				
	<b>Note:</b> Plug matches color on interior of unit. Specify color when ordering.			Order No.
				By description
Screw - Spring Clip				
	<b>Description</b>			Order No.
	#7 x 5/8" stainless steel pan head type AB			By description
	<b>Note:</b> Two used with each spring clip.			

**Frames**

<b>Frames</b>					
<b>Frames</b>					
<b>Unit No.</b>	<b>Dimensions</b>	<b>Terratone</b>	<b>Unit No.</b>	<b>Dimensions</b>	<b>Terratone</b>
SKS 1638/3816	16 1/4 × 37 3/4	1880450	SKS 2472/7224	24 1/4 × 26 3/4	1880456
SKS 1646/4616	16 1/4 × 45 3/4	1880451	SKS 2838/3828	27 1/4 × 37 3/4	1880457
SKS 2427/2724	24 1/4 × 26 3/4	1880452	SKS 2846/4628	27 1/4 × 45 3/4	1880458
SKS 2438/3824	24 1/4 × 37 3/4	1880453	SKS 2857/5728	27 1/4 × 56 3/4	1880459
SKS 2446/4624	24 1/4 × 45 3/4	1880454	SKS 2872/7228	27 1/4 × 71 3/4	1880460
SKS 2457/5724	24 1/4 × 56 3/4	1880455	SKS 4446/4644	43 1/4 × 45 3/4	1880461

<b>Frame Parts</b>	
<b>Bracket - Standard / Fold Out</b>	
	<b>Order No.</b>
	1857928
<b>Bracket - Straight / Mounting</b>	
	<b>Order No.</b>
	By description
<b>Screw - Mounting Bracket</b>	
	<b>Order No.</b>
	N/A

# Skylight (SKS) and Skylight (SK) Windows (1991 to 2009)

*Snap Fit Skylight (SKS) Windows (1999 to 2009)*

## Flashing

### Flashing

Flashing - Shingle Step	
	<b>Order No.</b>
	1838528

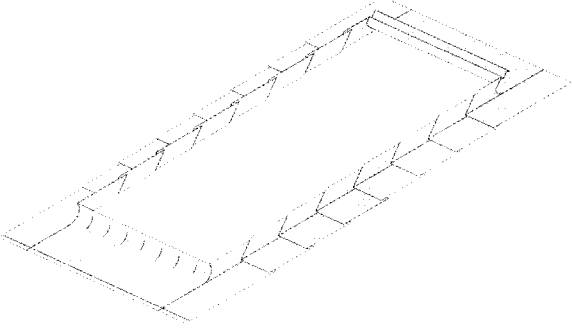
Flashing - Shingle																																					
	<table border="1" style="width: 100%; border-collapse: collapse;"> <thead> <tr style="background-color: #cccccc;"> <th style="text-align: left; padding: 5px;">Unit No.</th> <th style="text-align: left; padding: 5px;">Order No.</th> </tr> </thead> <tbody> <tr><td style="padding: 5px;"><b>SK/SKS 1638</b></td><td style="padding: 5px;">1880198</td></tr> <tr><td style="padding: 5px;"><b>SK/SKS 1646</b></td><td style="padding: 5px;">N/A</td></tr> <tr><td style="padding: 5px;"><b>SK/SKS 2127</b></td><td style="padding: 5px;">N/A</td></tr> <tr><td style="padding: 5px;"><b>SK/SKS 2138</b></td><td style="padding: 5px;">1852706</td></tr> <tr><td style="padding: 5px;"><b>SK/SKS 2146</b></td><td style="padding: 5px;">N/A</td></tr> <tr><td style="padding: 5px;"><b>SK/SKS 2157</b></td><td style="padding: 5px;">1852714</td></tr> <tr><td style="padding: 5px;"><b>SK/SKS 2172</b></td><td style="padding: 5px;">N/A</td></tr> <tr><td style="padding: 5px;"><b>SK/SKS 2427</b></td><td style="padding: 5px;">1880201</td></tr> <tr><td style="padding: 5px;"><b>SK/SKS 2438</b></td><td style="padding: 5px;">1880202</td></tr> <tr><td style="padding: 5px;"><b>SK/SKS 2446</b></td><td style="padding: 5px;">1880203</td></tr> <tr><td style="padding: 5px;"><b>SK/SKS 2457</b></td><td style="padding: 5px;">N/A</td></tr> <tr><td style="padding: 5px;"><b>SK/SKS 2472</b></td><td style="padding: 5px;">1880205</td></tr> <tr><td style="padding: 5px;"><b>SK/SKS 2838</b></td><td style="padding: 5px;">N/A</td></tr> <tr><td style="padding: 5px;"><b>SK/SKS 2846</b></td><td style="padding: 5px;">N/A</td></tr> <tr><td style="padding: 5px;"><b>SK/SKS 2857</b></td><td style="padding: 5px;">N/A</td></tr> <tr><td style="padding: 5px;"><b>SK/SKS 2872</b></td><td style="padding: 5px;">1852728</td></tr> <tr><td style="padding: 5px;"><b>SK/SKS 4446</b></td><td style="padding: 5px;">N/A</td></tr> </tbody> </table>	Unit No.	Order No.	<b>SK/SKS 1638</b>	1880198	<b>SK/SKS 1646</b>	N/A	<b>SK/SKS 2127</b>	N/A	<b>SK/SKS 2138</b>	1852706	<b>SK/SKS 2146</b>	N/A	<b>SK/SKS 2157</b>	1852714	<b>SK/SKS 2172</b>	N/A	<b>SK/SKS 2427</b>	1880201	<b>SK/SKS 2438</b>	1880202	<b>SK/SKS 2446</b>	1880203	<b>SK/SKS 2457</b>	N/A	<b>SK/SKS 2472</b>	1880205	<b>SK/SKS 2838</b>	N/A	<b>SK/SKS 2846</b>	N/A	<b>SK/SKS 2857</b>	N/A	<b>SK/SKS 2872</b>	1852728	<b>SK/SKS 4446</b>	N/A
Unit No.	Order No.																																				
<b>SK/SKS 1638</b>	1880198																																				
<b>SK/SKS 1646</b>	N/A																																				
<b>SK/SKS 2127</b>	N/A																																				
<b>SK/SKS 2138</b>	1852706																																				
<b>SK/SKS 2146</b>	N/A																																				
<b>SK/SKS 2157</b>	1852714																																				
<b>SK/SKS 2172</b>	N/A																																				
<b>SK/SKS 2427</b>	1880201																																				
<b>SK/SKS 2438</b>	1880202																																				
<b>SK/SKS 2446</b>	1880203																																				
<b>SK/SKS 2457</b>	N/A																																				
<b>SK/SKS 2472</b>	1880205																																				
<b>SK/SKS 2838</b>	N/A																																				
<b>SK/SKS 2846</b>	N/A																																				
<b>SK/SKS 2857</b>	N/A																																				
<b>SK/SKS 2872</b>	1852728																																				
<b>SK/SKS 4446</b>	N/A																																				

Flashing - Shingle / 90°													
	<table border="1" style="width: 100%; border-collapse: collapse;"> <thead> <tr style="background-color: #cccccc;"> <th style="text-align: left; padding: 5px;">Unit No.</th> <th style="text-align: left; padding: 5px;">Order No.</th> </tr> </thead> <tbody> <tr><td style="padding: 5px;"><b>SK/SKS 27</b></td><td style="padding: 5px;">1852736</td></tr> <tr><td style="padding: 5px;"><b>SK/SKS 38</b></td><td style="padding: 5px;">1852738</td></tr> <tr><td style="padding: 5px;"><b>SK/SKS 46</b></td><td style="padding: 5px;">N/A</td></tr> <tr><td style="padding: 5px;"><b>SK/SKS 57</b></td><td style="padding: 5px;">N/A</td></tr> <tr><td style="padding: 5px;"><b>SK/SKS 72</b></td><td style="padding: 5px;">1852744</td></tr> </tbody> </table>	Unit No.	Order No.	<b>SK/SKS 27</b>	1852736	<b>SK/SKS 38</b>	1852738	<b>SK/SKS 46</b>	N/A	<b>SK/SKS 57</b>	N/A	<b>SK/SKS 72</b>	1852744
Unit No.	Order No.												
<b>SK/SKS 27</b>	1852736												
<b>SK/SKS 38</b>	1852738												
<b>SK/SKS 46</b>	N/A												
<b>SK/SKS 57</b>	N/A												
<b>SK/SKS 72</b>	1852744												

## Flashing

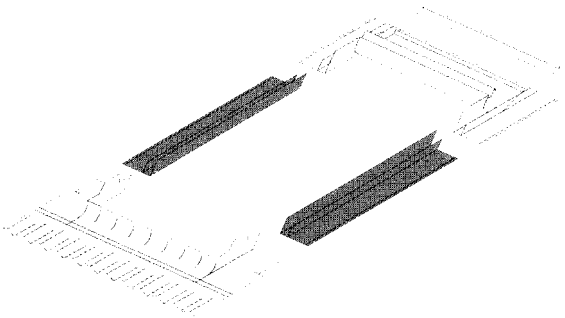
Flashing - Tile		
	<b>Unit No.</b>	<b>Order No.</b>
	SK/SKS 2127	N/A
	SK/SKS 2138	N/A
	SK/SKS 2146	N/A
	SK/SKS 2157	N/A
	SK/SKS 2172	1852816
	SK/SKS 2427	1880208
	SK/SKS 2438	1880209
	SK/SKS 2446	1880210
	SK/SKS 2457	1880211
	SK/SKS 2472	1880212
	SK/SKS 2838	N/A
	SK/SKS 2846	N/A
	SK/SKS 2857	N/A
	SK/SKS 2872	1852828
SK/SKS 4446	N/A	

Flashing - Tile / 90°		
	<b>Unit No.</b>	<b>Order No.</b>
	SK/SKS 2721	N/A
	SK/SKS 2724	1880215
	SK/SKS 3821	1852836
	SK/SKS 3824	1880216
	SK/SKS 3828	N/A
	SK/SKS 4621	1852838
	SK/SKS 4624	N/A
	SK/SKS 4628	N/A
	SK/SKS 4644	N/A
	SK/SKS 5724	N/A
	SK/SKS 5728	N/A

# Skylight (SKS) and Skylight (SK) Windows (1991 to 2009)

*Snap Fit Skylight (SKS) Windows (1999 to 2009)*

## Flashing

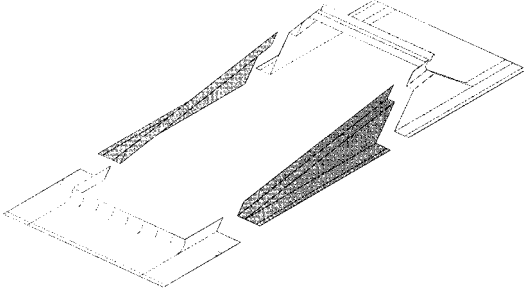
Flashing - Incline Curb			
		<b>Unit No.</b>	<b>Order No.</b>
		SK/SKS 1638	N/A
		SK/SKS 1646	
		SK/SKS 2127	
		SK/SKS 2138	
		SK/SKS 2146	
		SK/SKS 2157	
		SK/SKS 2427	
		SK/SKS 2438	
		SK/SKS 2446	
		SK/SKS 2457	
		SK/SKS 2838	
		SK/SKS 2846	
		SK/SKS 2857	
SK/SKS 4446			

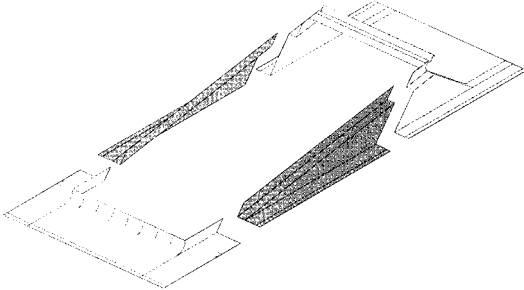
Flashing - Incline Curb / 90°			
		<b>Unit No.</b>	<b>Order No.</b>
		SK/SKS 2721	N/A
		SK/SKS 2724	
		SK/SKS 3816	
		SK/SKS 3821	
		SK/SKS 3824	
		SK/SKS 3828	
		SK/SKS 4616	
		SK/SKS 4621	
		SK/SKS 4624	
		SK/SKS 4628	
		SK/SKS 4644	
		SK/SKS 5721	
		SK/SKS 5724	
SK/SKS 5728			
SK/SKS 5744			

## Flashing

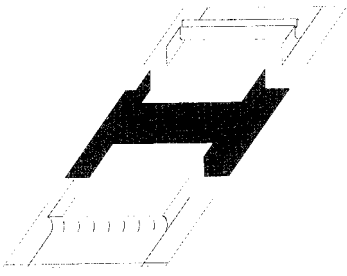
Flashing - Transom			
		Unit No.	Order No.
		SK/SKS 16	N/A
		SK/SKS 21	
		SK/SKS 24	
		SK/SKS 28	
		SK/SKS 44	

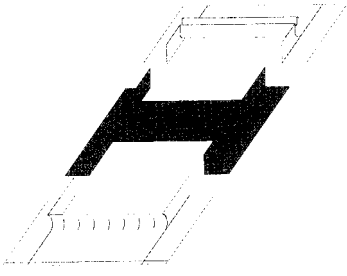
Flashing - Transom / 90°			
		Unit No.	Order No.
		SK/SKS 27	N/A
		SK/SKS 38	
		SK/SKS 46	
		SK/SKS 57	
		SK/SKS 72	

# Skylight (SKS) and Skylight (SK) Windows (1991 to 2009)

*Snap Fit Skylight (SKS) Windows (1999 to 2009)*

## Flashing

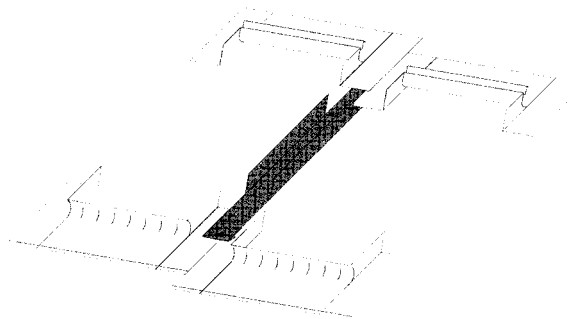
<b>Flashing - Mullion</b>				
	<b>Unit No.</b>	<b>2 1/2"</b>	<b>4"</b>	<b>7"</b>
	<b>SK/SKS 27</b>	N/A	N/A	N/A
	<b>SK/SKS 38</b>			
	<b>SK/SKS 46</b>			
	<b>SK/SKS 57</b>			
	<b>SK/SKS 72</b>			

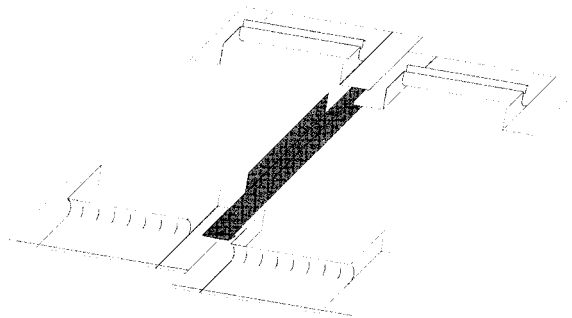
<b>Flashing - Mullion / 90°</b>				
	<b>Unit No.</b>	<b>2 1/2"</b>	<b>4"</b>	<b>7"</b>
	<b>SK/SKS 16</b>	N/A	N/A	N/A
	<b>SK/SKS 21</b>			
	<b>SK/SKS 24</b>			
	<b>SK/SKS 28</b>			
	<b>SK/SKS 44</b>			

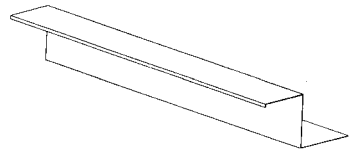
<b>Water Deflector</b>						
<b>Water Deflector</b>						
	<b>Unit No.</b>	<b>Dimension</b>	<b>Order No.</b>	<b>Unit No.</b>	<b>Dimension</b>	<b>Order No.</b>
	<b>SK/SKS 16</b>	17	1880206	<b>SK/SKS 38</b>	39	1857028
	<b>SK/SKS 21</b>	22 1/2	1857020	<b>SK/SKS 44</b>	45	1857024
	<b>SK/SKS 24</b>	25	1880207	<b>SK/SKS 46</b>	47	1857030
	<b>SK/SKS 27</b>	28	1857026	<b>SK/SKS 57</b>	58	1857032
	<b>SK/SKS 28</b>	29	1857022	<b>SK/SKS 72</b>	73	1857034

Shades

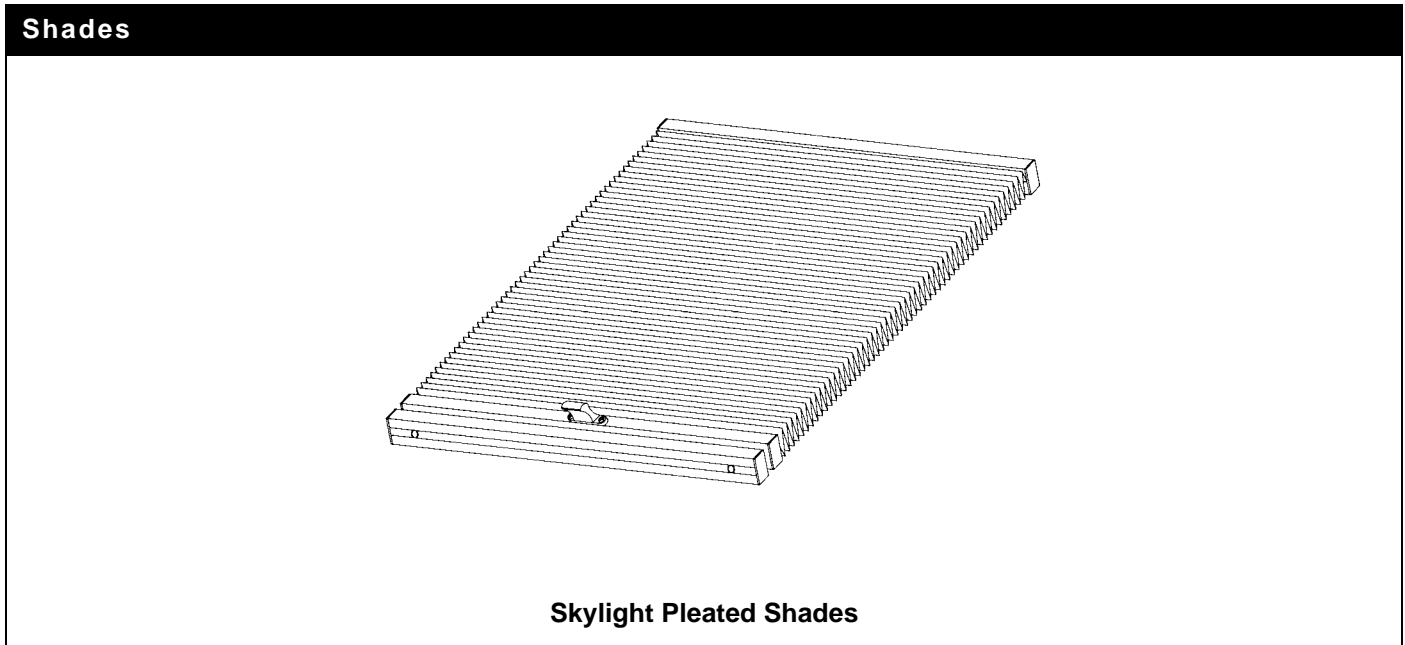

Shades							
Note:							
Shade includes handles, fasteners and instruction guide. Opaque shades block light; translucent shades let light through.							
Unit No.	Dimensions (w x h)	Opaque (Privacy)	Translucent (Sheer)	Unit No.	Dimensions (w x h)	Opaque (Privacy)	Translucent (Sheer)
SK/SKS 1638	12 1/2 x 34 1/4	1880170	1880184	SK/SKS 2857	24 x 42 1/4	1852326	1852626
SK/SKS 1646	12 1/2 x 42 1/4	1880171	1880185	SK/SKS 2872	24 x 53 1/4	1852328	1852628
SK/SKS 2127	17 1/2 x 23 1/4	1852302	N/A	SK/SKS 3816	24 x 68 1/4	1880177	1880191
SK/SKS 2138	17 1/2 x 34 1/4	1852306	N/A	SK/SKS 3824	34 x 12 3/4	1880180	1880194
SK/SKS 2146	17 1/2 x 42 1/4	1852310	N/A	SK/SKS 3828	34 x 20 3/4	1852368	1852668
SK/SKS 2157	17 1/2 x 53 1/4	1852314	N/A	SK/SKS 4446	40 x 42 1/4	1852330	1852630
SK/SKS 2172	17 1/2 x 68 1/4	1852316	N/A	SK/SKS 4616	42 x 12 3/4	1880178	1880192
SK/SKS 2427	20 1/2 x 23 1/4	1880172	1880186	SK/SKS 4624	42 x 20 3/4	1880181	1880195
SK/SKS 2438	20 1/2 x 34 1/4	1880173	1880187	SK/SKS 4628	42 x 24 1/4	1852372	1852672
SK/SKS 2446	20 1/2 x 42 1/4	1880174	1880188	SK/SKS 4644	42 x 40 1/4	1852380	1852680
SK/SKS 2457	20 1/2 x 53 1/4	1880175	1880189	SK/SKS 5724	53 x 20 3/4	1880182	1880196
SK/SKS 2472	20 1/2 x 68 1/4	1880176	1880190	SK/SKS 5728	53 x 24 1/4	1852376	1852676
SK/SKS 2724	23 1/2 x 20 3/4	1880179	1880193	SK/SKS 7224	68 x 20 3/4	1880183	1880197
SK/SKS 2838	24 x 34 1/4	1852318	1852618	SK/SKS 7228	68 x 24 1/4	1852378	1852678
SK/SKS 2846	24 x 42 1/4	1852322	1852622				

# Skylight (SKS) and Skylight (SK) Windows (1991 to 2009)

*Snap Fit Skylight (SKS) Windows (1999 to 2009)*



## Shades

### Shade Parts

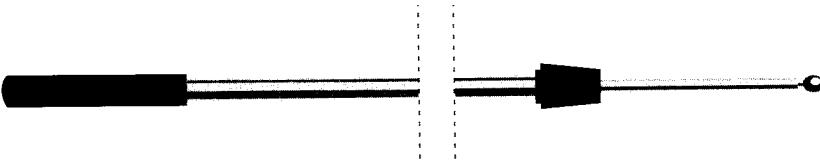
#### Extension Pole - Shade

	<p><b>Note:</b> Pole adjusts from 6' to 11'.</p>	<p><b>Order No.</b> 1853306</p>
---	--	-------------------------------------

#### Extension Pole Handle Kit - Pleated Shade

<p>Easy Access </p> <p>Modified for Remote Access </p>	<p><b>Note:</b> Kit includes easy access handle and remote access handle.</p>	<p><b>Order No.</b> 1890103</p>
--	---	-------------------------------------

#### Socket - Hex Ball

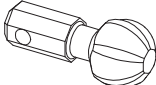
		<p><b>Order No.</b> 1880269</p>
---	--	-------------------------------------

#### Screw

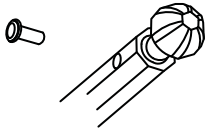
	<p><b>Description</b> #10-32 x 3/8"</p>	<p><b>Order No.</b> By description</p>
---	---	--

#### Clip - Mounting

	<p><b>Length</b> 5/8" x 1 1/4"</p>	<p><b>Order No.</b> 8268003</p>
--	--	-------------------------------------

**Notes**

---

# Skylight (SKS) and Skylight (SK) Windows (1991 to 2009)

*Skylight (SK) Units (1991 to 1999)*

## Skylight (SK) Units (1991 to 1999)

### Parts Illustration

#### Parts Illustration

**Note:**

SK Units use SKS flashing [page 9](#) and shades [page 14](#) for replacement.

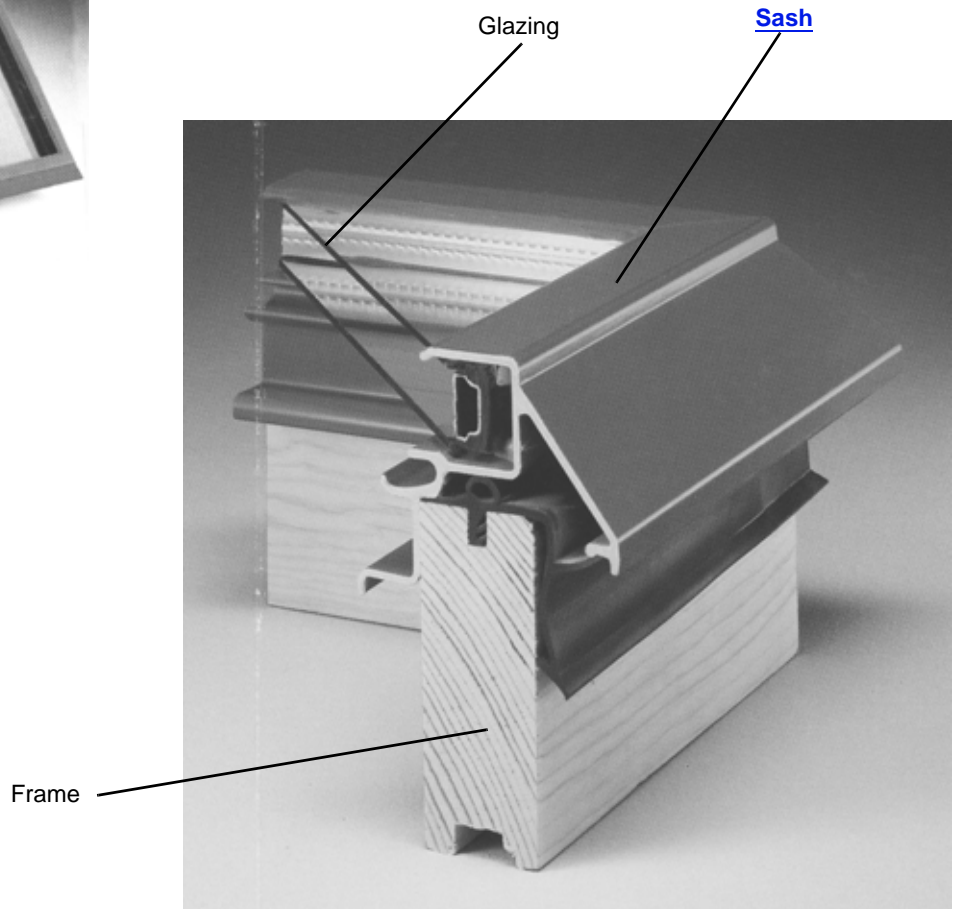
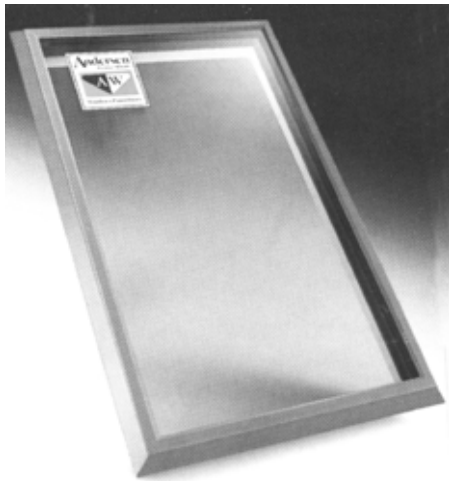

**Manufactured 1991 to 1999**

#### **Skylight (SK) Unit Parts (Non-Venting Only)**

*Unit viewed from exterior.*

## Unit Sizes

### Unit Size Chart

**Note:**

Unit Dimension refers to overall outside-to-outside frame. Unobstructed Glass refers to visible glass dimensions. Numbers in parentheses are metric measurements.

	16 1/2" (419)	21 1/2" (546)	24 1/2" (622)	28" (711)	44" (1118)
<b>= Rough Opening</b>	17" (432)	22" (559)	25" (635)	28 1/2" (724)	44 1/2" (1130)
<b>* Rough Opening</b>	14 1/2" (368)	19 1/2" (495)	22 1/2" (572)	26" (660)	42" (1067)
<b>Unobstructed Glass</b>	14" (356)	19" (483)	22" (559)	25 1/2" (648)	41 1/2" (1054)

27" (686)	25" (635)	24 1/2" (622)			
		<b>SK2127</b>	<b>SK2427</b>		
38" (965)	36" (914)	35 1/2" (902)			
	<b>SK1638</b>	<b>SK2138</b>	<b>SK2438</b>	<b>SK2838</b>	
46" (1168)	44" (1118)	43 1/2" (1105)			
	<b>SK1646</b>	<b>SK2146</b>	<b>SK2446</b>	<b>SK2846</b>	<b>SK4446</b>
57" (1448)	55" (1397)	54 1/2" (1384)			
	<b>SK2157</b>	<b>SK2457</b>	<b>SK2857</b>	<b>SK4457</b>	<b>SKS 4457</b>
72" (1829)	70" (1778)	69 1/2" (1765)			
	<b>SK2172</b>	<b>SK2472</b>	<b>SK2872</b>		

	27" (686)	38" (965)	46" (1168)	57" (1448)	72" (1829)
<b>Rough Opening</b>	25" (635)	36" (914)	44" (1118)	55" (1397)	70" (1778)
<b>Unobstructed Glass</b>	24 1/2" (622)	35 1/2" (902)	43 1/2" (1105)	54 1/2" (1384)	69 1/2" (1765)

16 1/2" (419)	17" (432)	14" (356)			
		<b>SK3816</b>	<b>SK4616</b>		
21 1/2" (546)	22" (559)	19" (483)			
	<b>SK2721</b>	<b>SK3821</b>	<b>SK4621</b>	<b>SK5721</b>	<b>SK7221</b>
24 1/2" (622)	25" (635)	22" (559)			
	<b>SK2724</b>	<b>SK3824</b>	<b>SK4624</b>	<b>SK5724</b>	<b>SK7224</b>
28" (711)	28 1/2" (724)	25 1/2" (648)			
	<b>SK3828</b>	<b>SK4628</b>	<b>SK5728</b>	<b>SK7228</b>	
44" (1118)	44 1/2" (1130)	41 1/2" (1054)			
		<b>SK4644</b>	<b>SKS 5744</b>		

1991 to 1999; Some Replacement Parts Available

### Skylight (SK) Unit Sizes

*Unit viewed from exterior.*

# Skylight (SKS) and Skylight (SK) Windows (1991 to 2009)

*Skylight (SK) Units (1991 to 1999)*

## Sash

### Glass Size Table

**Note:**

Overall Sash is measured outside edge to outside edge of frame.

Unobstructed Glass is dimension from outside edge to outside edge of visible glass only.

Actual Glass is dimension of outside edge to outside edge of glass, including glass that is not visible.

### Glass Size Table

Unit No.	Unobstructed Glass (w x h)	Actual Glass (w x h)	Unit No.	Unobstructed Glass (w x h)	Actual Glass (w x h)
SK 1638	14 × 35 1/2	15 11/16 × 37 3/16	SK 3816	35 1/2 × 14	37 3/16 × 15 11/16
SK 1646	14 × 43 1/2	15 11/16 × 45 3/16	SK 3821	35 1/2 × 19	37 3/16 × 20 11/16
SK 2127	19 × 24 1/2	20 11/16 × 26 3/16	SK 3824	35 1/2 × 22	37 3/16 × 23 11/16
SK 2138	19 × 35 1/2	20 11/16 × 37 3/16	SK 3828	35 1/2 × 25 1/2	37 3/16 × 27 11/16
SK 2146	19 × 43 1/2	20 11/16 × 45 3/16	SK 4446	41 1/2 × 43 1/2	43 3/16 × 45 3/16
SK 2157	19 × 54 1/2	20 11/16 × 56 3/16	SK 4457	41 1/2 × 54 1/2	43 3/16 × 56 3/16
SK 2172	19 × 69 1/2	20 11/16 × 71 3/16	SK 4616	43 1/2 × 14	45 3/16 × 15 11/16
SK 2427	22 × 24 1/2	23 11/16 × 26 3/16	SK 4621	43 1/2 × 19	45 3/16 × 20 11/16
SK 2438	22 × 35 1/2	23 11/16 × 37 3/16	SK 4624	43 1/2 × 22	45 3/16 × 23 11/16
SK 2446	22 × 43 1/2	23 11/16 × 45 3/16	SK 4628	43 1/2 × 25 1/2	45 3/16 × 27 11/16
SK 2457	22 × 54 1/2	23 11/16 × 56 3/16	SK 4644	43 1/2 × 41 1/2	45 3/16 × 43 11/16
SK 2472	22 × 69 1/2	23 11/16 × 71 3/16	SK 5721	54 1/2 × 19	56 3/16 × 20 11/16
SK 2721	24 1/2 × 19	26 3/16 × 20 11/16	SK 5724	54 1/2 × 22	56 3/16 × 23 11/16
SK 2724	24 1/2 × 22	26 3/16 × 23 11/16	SK 5728	54 1/2 × 25 1/2	56 3/16 × 27 11/16
SK 2838	25 1/2 × 35 1/2	27 3/16 × 37 3/16	SK 7221	69 1/2 × 19	71 3/16 × 20 11/16
SK 2846	25 1/2 × 43 1/2	27 3/16 × 45 3/16	SK 7224	69 1/2 × 22	71 3/16 × 23 11/16
SK 2857	25 1/2 × 54 1/2	27 3/16 × 56 3/16	SK 7228	69 1/2 × 25 1/2	71 3/16 × 27 11/16
SK 2872	25 1/2 × 69 1/2	27 3/16 × 71 3/16			

# Sash

## Sash and Frame Assembly

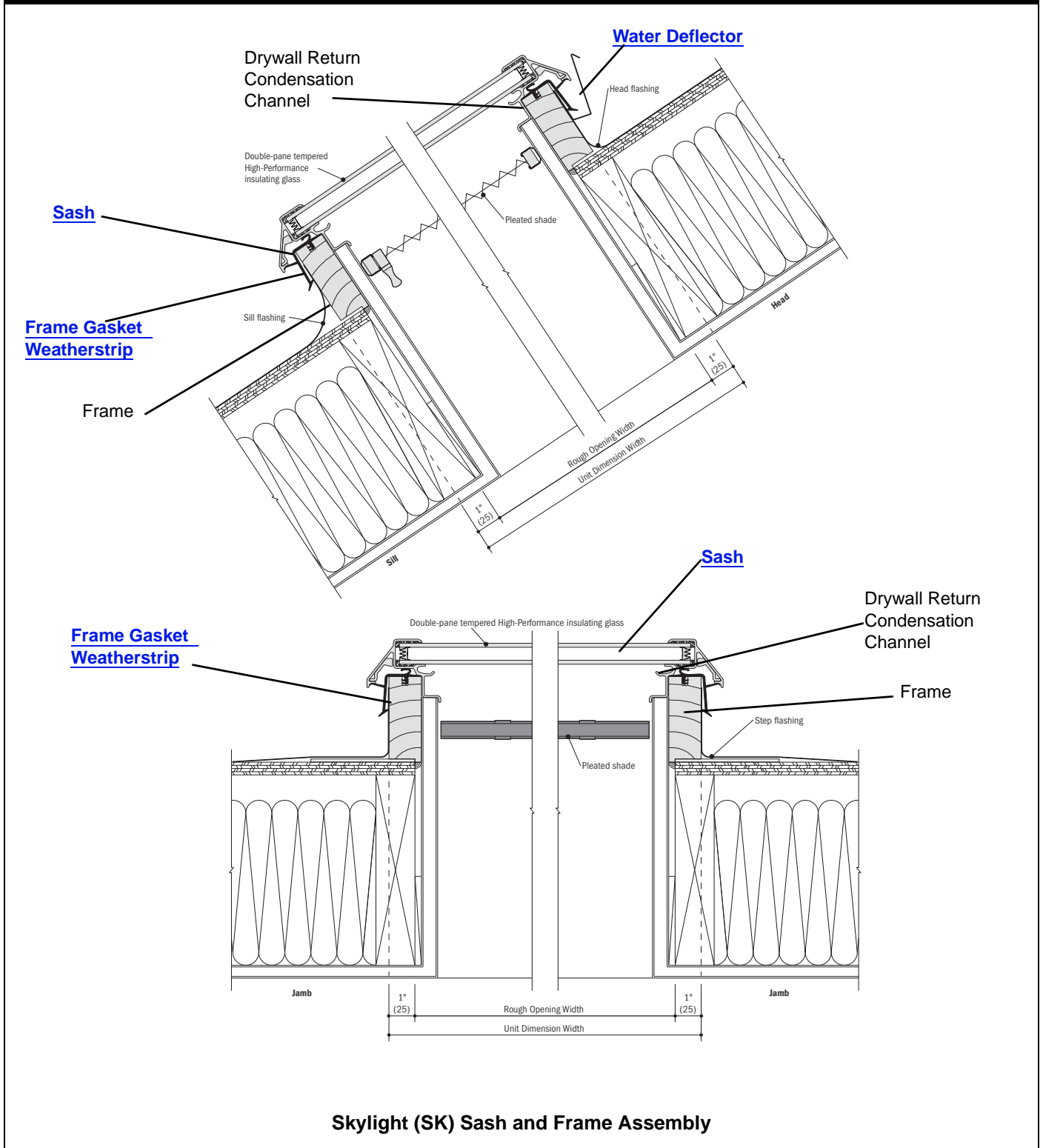

# Skylight (SKS) and Skylight (SK) Windows (1991 to 2009)

*Skylight (SK) Units (1991 to 1999)*

## Sash

### Sash

Sash - High-Performance Tempered					
Unit No.	Terratone	Unit No.	Terratone	Unit No.	Terratone
SK 1638/3816	1880129	SK 2172/7221	1855816	SK 2838/3828	1855818
SK 1646/4616	1880130	SK 2427/2724	1880131	SK 2846/4628	1855822
SK 2127/2721	1855802	SK 2438/3824	1880132	SK 2857/5728	1855826
SK 2138/3821	1855806	SK 2446/4624	1880133	SK 2872/7228	1855828
SK 2146/4621	1855810	SK 2457/5724	1880134	SK 4446/4644	1855830
SK 2157/5721	1855814	SK 2472/7224	1880135	SK 4457/5744	1855834

Sash - High-Performance Sun 3 Tempered					
Unit No.	Terratone	Unit No.	Terratone	Unit No.	Terratone
SK 1638/3816	1880143	SK 2172/7221	1856016	SK 2838/3828	1856018
SK 1646/4616	1880144	SK 2427/2724	1880145	SK 2846/4628	1856022
SK 2127/2721	1856002	SK 2438/3824	1880146	SK 2857/5728	1856026
SK 2138/3821	1856006	SK 2446/4624	1880147	SK 2872/7228	1856028
SK 2146/4621	1856010	SK 2457/5724	1880148	SK 4446/4644	1856030
SK 2157/5721	1856014	SK 2472/7224	1880149	SK 4457/5744	1856034

### Sash - High-Performance Sun II Tempered

**Note:**

Available by description.

Sash - High-Performance Tempered Laminated					
Unit No.	Terratone	Unit No.	Terratone	Unit No.	Terratone
SK 1638/3816	1880136	SK 2172/7221	OBD	SK 2838/3828	1855918
SK 1646/4616	1880137	SK 2427/2724	1880138	SK 2846/4628	1855922
SK 2127/2721	1855902	SK 2438/3824	1880139	SK 2857/5728	1855926
SK 2138/3821	1855906	SK 2446/4624	1880140	SK 2872/7228	1855928
SK 2146/4621	1855910	SK 2457/5724	1880141	SK 4446/4644	1855930
SK 2157/5721	1855914	SK 2472/7224	1880142	SK 4457/5744	1855934

## Sash

---

<b>Sash - High-Performance Sun 3 Tempered Laminated</b>					
<b>Unit No.</b>	<b>Terratone</b>	<b>Unit No.</b>	<b>Terratone</b>	<b>Unit No.</b>	<b>Terratone</b>
<b>SK 1638/3816</b>	1880150	<b>SK 2172/7221</b>	OBD	<b>SK 2838/3828</b>	1856118
<b>SK 1646/4616</b>	1880151	<b>SK 2427/2724</b>	1880152	<b>SK 2846/4628</b>	1856122
<b>SK 2127/2721</b>	OBD	<b>SK 2438/3824</b>	1880153	<b>SK 2857/5728</b>	1856126
<b>SK 2138/3821</b>	OBD	<b>SK 2446/4624</b>	1880154	<b>SK 2872/7228</b>	1856128
<b>SK 2146/4621</b>	OBD	<b>SK 2457/5724</b>	1880155	<b>SK 4446/4644</b>	1856130
<b>SK 2157/5721</b>	OBD	<b>SK 2472/7224</b>	1880156	<b>SK 4457/5744</b>	1856134

<b>Sash - High-Performance Sun II Tempered Laminated</b>
<b>Note:</b> Available by description.

# Skylight (SKS) and Skylight (SK) Windows (1991 to 2009)

*Skylight (SK) Units (1991 to 1999)*

## Frames

<b>Frames</b>
<b>Frames</b>
<p><b>Note:</b> Replacement frames are not available. Replace with custom made SKS frame and flashing. Order by description.</p>

<b>Frame Gasket</b>			
<p><b>Note:</b> Frame gasket weatherstrip is the same as Roof venting and stationary windows. Use generic #1891100 when ordering by description.</p>			
<b>Frame Gasket</b>			
Unit No.	Order No.	Unit No.	Order No.
1638	By description	2457	By description
1646	By description	2472	By description
2127	1857302	2721	By description
2138	1857304	2724	By description
2146	1857306	2838	1857310
2157	1857308	2846	1857312
2172	By description	2857	1857314
2427	By description	2872	By description
2438	By description	4446	1857316
2446	By description	4457	By description

**Notes**

---

# Skylight (SKS) and Skylight (SK) Windows (1991 to 2009)

## Stormwatch™ Protection (Coastal Product)

Andersen® products with Stormwatch protection are designed for use in coastal areas. They feature design pressure upgrades, glass options, and structural enhancements.

### Sash

<b>Sash</b>		
<b>Sash - High-Performance Tempered Laminated (Impact Resistant)</b>		
	<b>Unit No.</b>	<b>Terratone</b>
	<b>SKS 1638/3816</b>	1845450
	<b>SKS 1646/4616</b>	1845451
	<b>SKS 2427/2724</b>	1845452
	<b>SKS 2438/3824</b>	1845453
	<b>SKS 2446/4624</b>	1845454
	<b>SKS 2838/3828</b>	1845455
	<b>SKS 2846/4628</b>	1845456

<b>Sash - High-Performance Sun 3 Tempered Laminated (Impact Resistant)</b>		
	<b>Unit No.</b>	<b>Terratone</b>
	<b>SKS 1638/3816</b>	1845460
	<b>SKS 1646/4616</b>	1845461
	<b>SKS 2427/2724</b>	1845462
	<b>SKS 2438/3824</b>	1845463
	<b>SKS 2446/4624</b>	1845464
	<b>SKS 2838/3828</b>	1845465
	<b>SKS 2846/4628</b>	1845466

<b>Sash - High-Performance Sun II Tempered Laminated (Impact Resistant)</b>		
<b>Note:</b> Available by description.		

# Skylight (SKS) and Skylight (SK) Windows (1991 to 2009)

---

*Stormwatch™ Protection (Coastal Product)*

## Notes

---