

What's in This Section

IMPORTANCE OF PROPER SELECTION:
 It is essential that you select the proper joining members for Andersen windows. Andersen strongly recommends consultation with an experienced structural engineer, contractor, architect or your local Andersen window supplier prior to the installation of any Andersen product. Installation of Andersen products is the sole responsibility of the architect, building owner, contractor, and/or consumer, and Andersen has no responsibility in this regard. For more information about joining materials, please see the Andersen Residential Product Guide, the Andersen Commercial Catalog, or the Andersen Architectural Detail File.

..... **Page 3**

Steel Reinforced Mullion **3**

Casement, Awning, Specialty, and Circle Top™ Windows 3

Tilt-Wash and Perma-Shield® Narroline® Windows 5

Aluminum Reinforced Mullion **7**

Casement, Awning, Specialty, and Circle Top™ Windows 7

Exterior Extension Jambs **9**

Extension Jamb Kit 9

Reinforced Mullion Joining Components (1990 to Present)

Steel Reinforced Mullion

Casement, Awning, Specialty, and Circle Top™ Windows

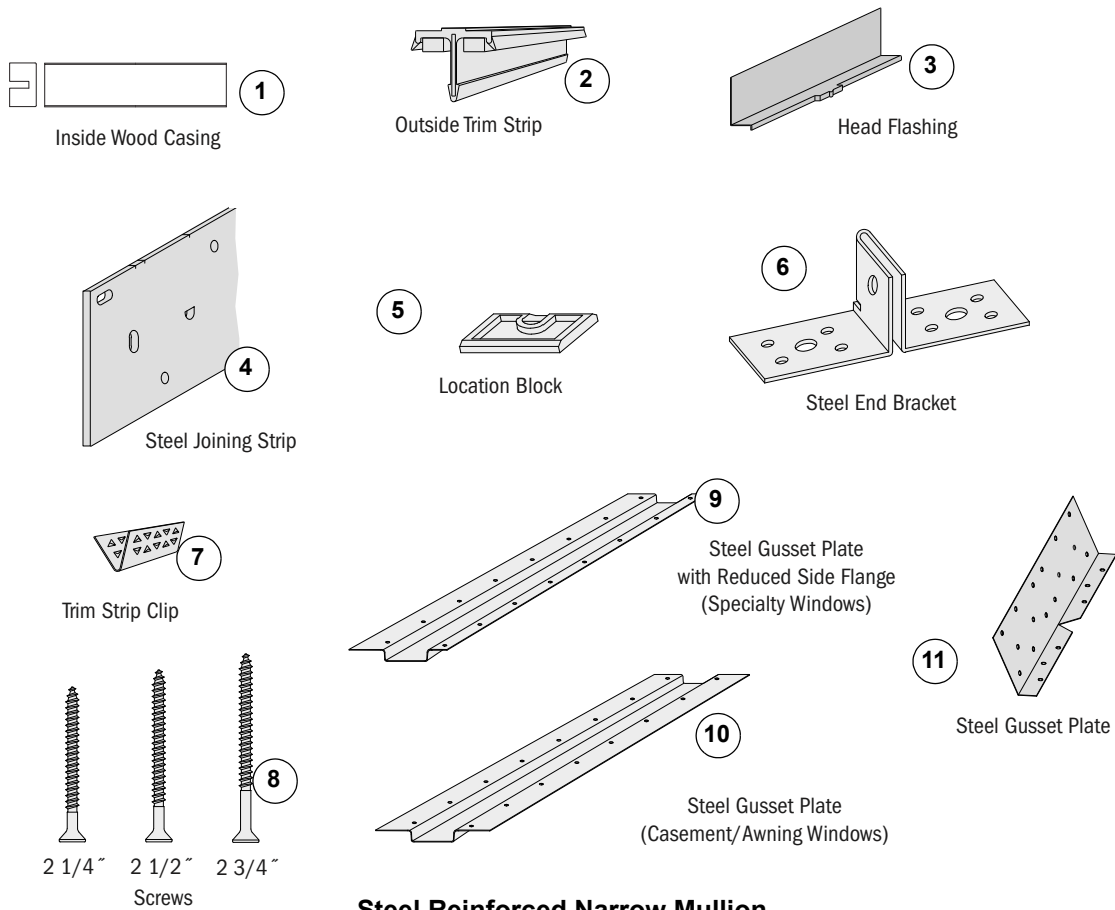

Steel Reinforced Narrow Mullion for Casement, Awning, Specialty, and Circle Top™ Windows

Inside Casing - Pine Ref. No. 1

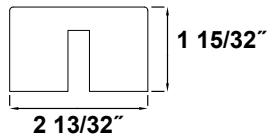

Length	2 3/8"	2 5/8"	2 15/16"
96 in	2340602	2340606	2340614
144 in	2340604	2340608	2340616

Inside Casing - White Prefinished Interior Ref. No. 1

Length	2 3/8"	2 5/8"	2 15/16"
96 in	2340617	2340619	2340621
144 in	2340618	2340620	2340622

Steel Reinforced Mullion

Exterior Trim Strip - Reinforced Mullion Ref. No. 2						
	Length	White	Terratone	Sandtone	Forest Green	Canvas
	96 in	2340504	2340508	2340512	2340528	9043184
	150 in	2340502	2340506	2340510	2340526	9043183
Exterior Flashing Ref. No. 3						
	Length	White	Terratone	Sandtone	Forest Green	Canvas
	6 in	1356008	1456008	0608402	0514129	9033568
Joining Strip - Steel Reinforced Mullion Ref. No. 4 page 3						
					Unit Size	Order No.
					96 1/4 in	2340406
					114 in	2340408
					150 in	2340410

End Bracket Kit - Steel Reinforced Mullion / PSC/A/CT/FF Ref. No. 5 to 8 page 3		
	Includes: Trim strip clip, screws, location block, and end bracket.	Order No.
		2340414
End Bracket - Steel Reinforced Mullion Ref. No. 6 page 3		
		Order No.
		2340424
Clip - Trim Strip / Reinforced Mullion Ref. No. 7 page 3		
		Order No.
		2340423
Gusset Plate Kit - Steel Reinforced Mullion / Doors / ET Ref. No. 11, 5, and 7 page 3		
	Includes: Gussets, location block, and screws.	Order No.
		2340416
Gusset Plate - Metal / PS/FF Ref. No. 9 page 3		
		Order No.
		2250208
Gusset Plate - Head and Sill Ref. No. 10 page 3		
		Order No.
		1359508
Gusset Plate - Reinforced Mullion Ref. No. 11 page 3		
		Order No.
		2340426
Gusset Plate - CTC/CTN/ET/DH		
		Order No.
		1359510

Reinforced Mullion Joining Components (1990 to Present)

Steel Reinforced Mullion

Tilt-Wash and Perma-Shield® Narroline® Windows

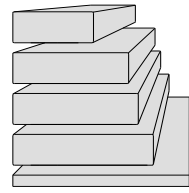

1 Inside Wood Casing

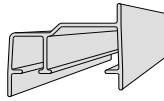

2 Reinforced Outside Trim Strip

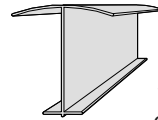

3 Vertical Outside Trim Strip

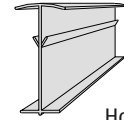

4 Horizontal Outside Trim Strip

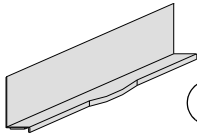

5 Head Flashing

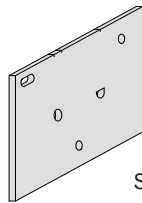

6 Steel Joining Strip

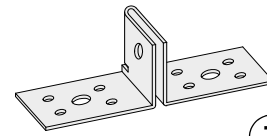

7 End Bracket

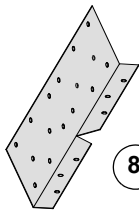

8 Steel Gusset Plate

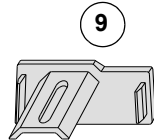

9 End Plug

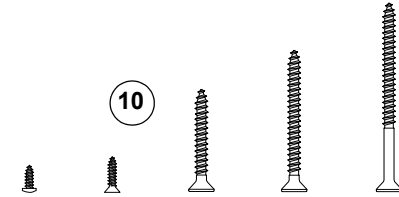

10 Screws
5/8" 7/8" 1 5/8" 2 1/4" 3"

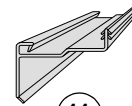

11 Transom Exterior Trim Piece

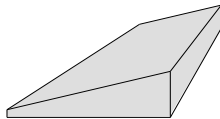

Wood Spacer Wedge

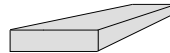

Head Jamb Filler



1/16" Vertical Spacer

Steel Reinforced Narrow Mullion for Double-Hung Windows

Inside Casing - Steel Reinforced Mullion Ref. No. 1

Note:
Inside wood casing must be modified. See installation instructions.

	Length	2 3/8"	2 5/8"	2 15/16"
	96 in	2340602	2340606	2340614
	144 in	2340604	2340608	2340616

Steel Reinforced Mullion

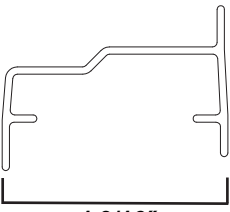
Exterior Trim Strip - FF/PSNL Ref. No. 2					
 <p style="text-align: center;">1 9/16"</p>	Length	White	Terratone	Sandtone	Forest Green
	96 in	2222002	2222022	2222032	N/A
	150 in	2222004	2222024	2222034	N/A
Exterior Trim Strip - TW / Vertical Ref. No. 3					
	Length	White	Terratone	Sandtone	Forest Green
	150 in	1632926	2741726	1142426	0331797
Exterior Trim Strip - Transom/PSNL / Reinforced / Horizontal Ref. No. 4 page 5					
	Length	White	Terratone	Sandtone	Forest Green
	150 in	2340520	2340522	2340524	2340526
Exterior Flashing Ref. No. 5 page 5					
	Length	White	Terratone	Sandtone	Forest Green
	6 in	1642208	2742208	1152904	0331798

Joining Strip - Steel Reinforced Mullion Ref. No. 6 page 5		
	Unit Size	Order No.
	96 1/4 in	2340406
	114 in	2340408
	150 in	2340410

End Bracket - Steel Ref. No. 7 page 5		
		Order No.
		2340424
Gusset Plate Kit - PSNL / Steel Reinforced Mullion Ref. No. 8 page 5		
		Order No.
		2340418
Exterior Trim Piece - Transom Ref. No. 11 page 5		
	Length	Order No.
	96 in	By description
	150 in	By description
End Plug - Transom / Left Hand and Right Hand Ref. No. 9 page 5		
	Color	Order No.
	White	2222052
	Gray	2222054

Reinforced Mullion Joining Components (1990 to Present)

Aluminum Reinforced Mullion

Casement, Awning, Specialty, and Circle Top™ Windows

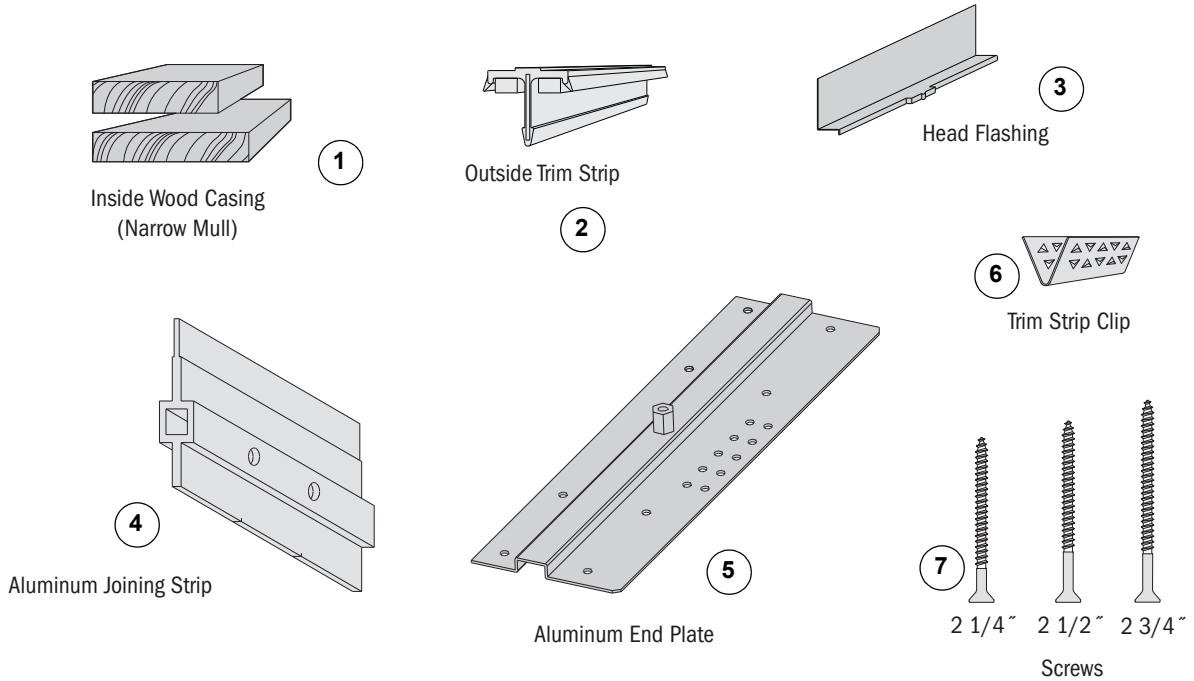

Aluminum Reinforced Narrow Mullion for Casement, Awning, Specialty, and Circle Top™ Windows

Inside Casing - Aluminum Reinforced Mullion Ref. No. 1

	Length	2 3/8"	2 5/8"	2 7/8"
		Casement to Casement	Casement to Flexiframe	Flexiframe to Flexiframe
96 in		1349022	1386812	1507622
144 in		1349024	1386814	1507624

Exterior Trim Strip - Reinforced Mullion Ref. No. 2

Unit Size	White	Terratone	Sandtone	Forest Green	Canvas
96 in	2340504	2340508	2340512	2340528	9043184
150 in	2340502	2340506	2340510	2340526	9043183

Exterior Flashing Ref. No. 3

Length	White	Terratone	Sandtone	Forest Green	Canvas
6 in	1356008	1456008	0608402	0514129	9033568

Joining Strip - Reinforced Mullion Ref. No. 4

Unit Size	Order No.
72 3/32 in	2340402
92 in	2340404

Aluminum Reinforced Mullion

End Plate Kit - Reinforced Mullion / PSC/A/CT/FF Ref. No. 5, 6, and 7 page 7	
Includes: End plates, trim strip clip, and screws	Order No. 2340412
End Plate - Reinforced Mullion Ref. No. 5 page 7	
	Order No. 2340422
Trim Clip - Reinforced Mullion Ref. No. 6 page 7	
	Order No. 2340423

Reinforced Mullion Joining Components (1990 to Present)

Exterior Extension Jamb

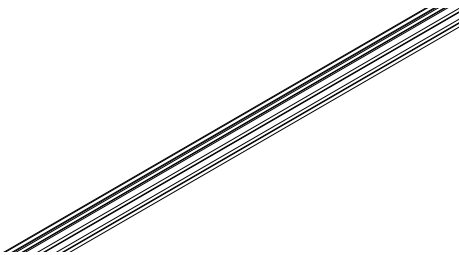
Extension Jamb Kit				
Extension Jamb Kit - Exterior				
		Unit No.	Dimension	Order No.
	Note: Kit has an aluminum joining strip. Use when joining a Frenchwood Hinged unit with an exterior extension jamb/double screen track applied to a Flexiframe transom unit.	FWH80	79 1/2	2579701

Notes
