

What's in This Section

Standard Windows	Page 3
Parts Illustration	3
Unit Sizes	4
Sash	5
Sash Size Table	5
Sash Assembly	6
Sash Hardware	7
Insect Screens	8
Insect Screen - Aluminum	8
Frames	10
Frame Assembly	10

Primed Gliding Windows (1940 to 1971)

Standard Windows

Parts Illustration

Parts Illustration

Note:

Limited replacement parts are available. The construction is all wood.

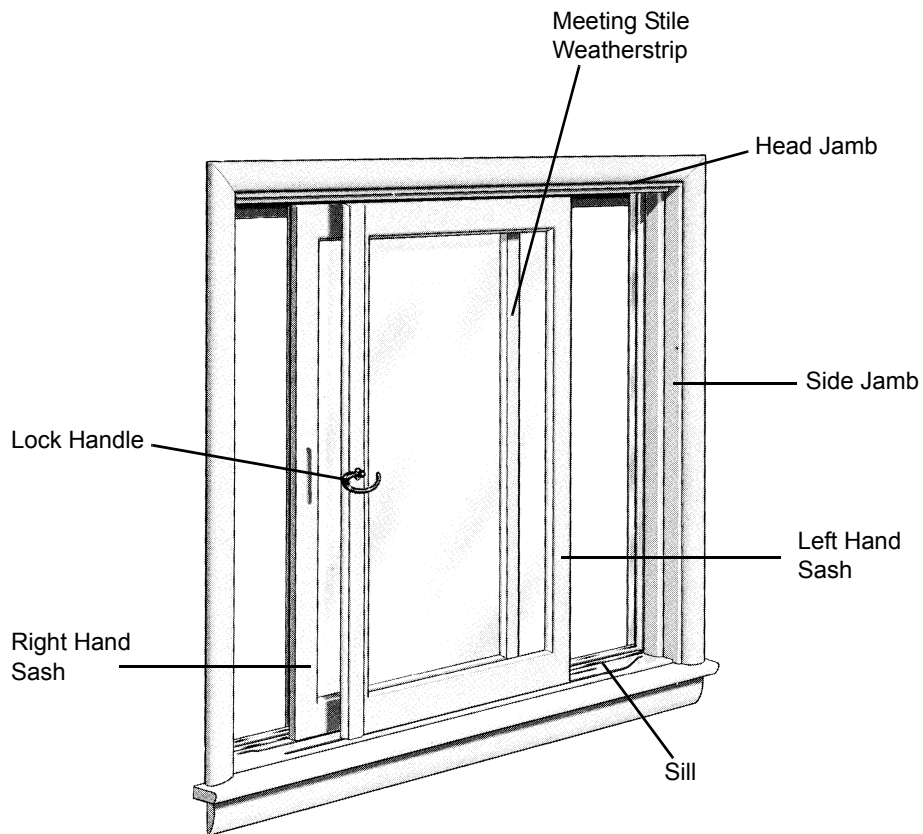

**Manufactured 1940 to 1971
Primed Gliding Window Unit Parts**

Unit viewed from interior.

Unit Sizes

Unit Size Chart

Note:

Unit Dim. refers to overall outside-to-outside frame. Rough Opening refers to rough stud opening. Sash Opening refers to clear opening dimensions. Glass Size refers to unobstructed (visible) glass dimensions.

UNIT DIM.	3-8	4-8	5-8
ROUGH OPENING	3-7 $\frac{1}{4}$ "	4-7 $\frac{1}{4}$ "	5-7 $\frac{1}{4}$ "
SASH OPENING	3-4 $\frac{3}{8}$ "	4-4 $\frac{3}{8}$ "	5-4 $\frac{3}{8}$ "
GLASS SIZE	16"	22"	28"

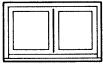
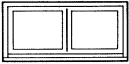
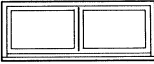
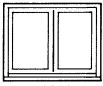
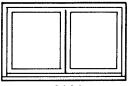
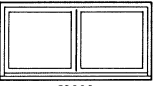
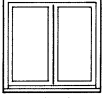
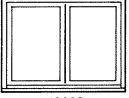
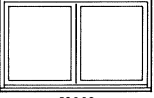
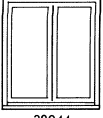
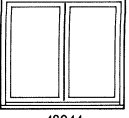
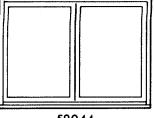
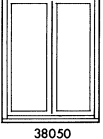
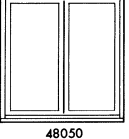
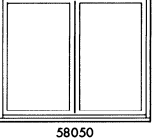
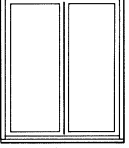
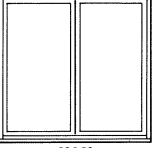
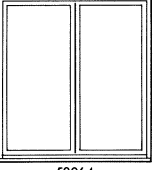
$2-2 \frac{5}{8}$ $2-2 \frac{1}{4}$ $1-11$ $17 \frac{9}{16}$			
38024	48024	58024	
$2-10 \frac{5}{8}$ $2-10 \frac{1}{4}$ $2-7$ $25 \frac{9}{16}$			
38030	48030	58030	
$3-6 \frac{5}{8}$ $3-6 \frac{1}{4}$ $3-3$ $33 \frac{9}{16}$			
38038	48038	58038	
$4-2 \frac{5}{8}$ $4-2 \frac{1}{4}$ $3-11$ $41 \frac{9}{16}$			
38044	48044	58044	
$4-10 \frac{5}{8}$ $4-10 \frac{1}{4}$ $4-7$ $49 \frac{9}{16}$			
38050	48050	58050	
$5-6 \frac{5}{8}$ $5-6 \frac{1}{4}$ $5-3$ $57 \frac{9}{16}$			
		48058	58058
$6-2 \frac{5}{8}$ $6-2 \frac{1}{4}$ $5-11$ $65 \frac{9}{16}$			
			58064

Primed Gliding Window Unit Sizes

Unit viewed from exterior.

Primed Gliding Windows (1940 to 1971)

Standard Windows

Sash

Sash Size Table

Note:

Overall Sash is measured outside edge to outside edge of frame.

Unobstructed Glass is dimension from outside edge to outside edge of visible glass only.

Actual Glass is dimension of outside edge to outside edge of glass, including glass that is not visible.

Sash Size Table - Standard Windows

Unit No.	Overall Sash (w x h)	Unobstructed Glass (w x h)	Actual Glass (w x h)
38024	20 ¹ / ₄ × 22 ⁵ / ₁₆	16 × 17 ⁹ / ₁₆	16 ⁷ / ₁₆ × 18
38030	20 ¹ / ₄ × 30 ⁵ / ₁₆	16 × 25 ⁹ / ₁₆	16 ⁷ / ₁₆ × 26
38038	20 ¹ / ₄ × 38 ⁵ / ₁₆	16 × 33 ⁹ / ₁₆	16 ⁷ / ₁₆ × 34
38044	20 ¹ / ₄ × 46 ⁵ / ₁₆	16 × 41 ⁹ / ₁₆	16 ⁷ / ₁₆ × 42
38050	20 ¹ / ₄ × 54 ⁵ / ₁₆	16 × 49 ⁹ / ₁₆	16 ⁷ / ₁₆ × 50
48024	26 ¹ / ₄ × 22 ⁵ / ₁₆	22 × 17 ⁹ / ₁₆	22 ⁷ / ₁₆ × 18
48030	26 ¹ / ₄ × 30 ⁵ / ₁₆	22 × 25 ⁹ / ₁₆	22 ⁷ / ₁₆ × 26
48038	26 ¹ / ₄ × 38 ⁵ / ₁₆	22 × 33 ⁹ / ₁₆	22 ⁷ / ₁₆ × 34
48044	26 ¹ / ₄ × 46 ⁵ / ₁₆	22 × 41 ⁹ / ₁₆	22 ⁷ / ₁₆ × 42
48050	26 ¹ / ₄ × 54 ⁵ / ₁₆	22 × 49 ⁹ / ₁₆	22 ⁷ / ₁₆ × 50
48058	26 ¹ / ₄ × 62 ⁵ / ₁₆	22 × 57 ⁹ / ₁₆	22 ⁷ / ₁₆ × 58
58024	32 ¹ / ₄ × 22 ⁵ / ₁₆	28 × 17 ⁹ / ₁₆	28 ⁷ / ₁₆ × 18
58030	32 ¹ / ₄ × 30 ⁵ / ₁₆	28 × 25 ⁹ / ₁₆	28 ⁷ / ₁₆ × 26
58038	32 ¹ / ₄ × 38 ⁵ / ₁₆	28 × 33 ⁹ / ₁₆	28 ⁷ / ₁₆ × 34
58044	32 ¹ / ₄ × 46 ⁵ / ₁₆	28 × 41 ⁹ / ₁₆	28 ⁷ / ₁₆ × 42
58050	32 ¹ / ₄ × 54 ⁵ / ₁₆	28 × 49 ⁹ / ₁₆	28 ⁷ / ₁₆ × 50
58058	32 ¹ / ₄ × 62 ⁵ / ₁₆	28 × 57 ⁹ / ₁₆	28 ⁷ / ₁₆ × 58
58064	32 ¹ / ₄ × 70 ⁵ / ₁₆	28 × 65 ⁹ / ₁₆	28 ⁷ / ₁₆ × 66

Sash

Sash Assembly

Note:

Insect Screen shown in illustration is wood insect screen. Wood is no longer available; replace with aluminum insect screens.

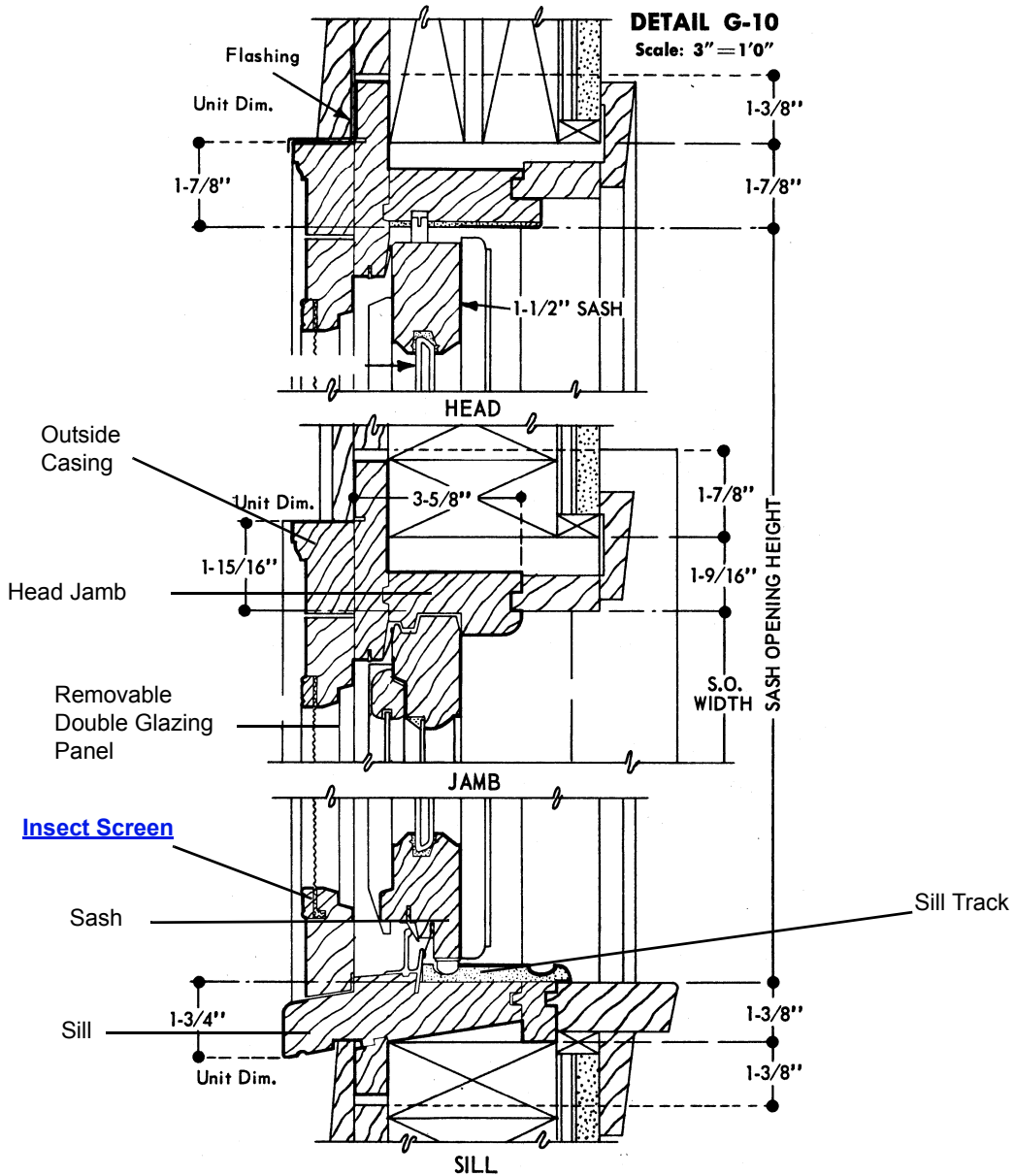

Primed Gliding Window Sash and Frame Assembly

Primed Gliding Windows (1940 to 1971)

Standard Windows

Sash

Sash Hardware

Lock Strike - Wing Blade (1968 to 1971)



1968 to
1971

Chrome

N/A

Lock Strike - Wing Blade (1940 to 1968)

Note:

Wing blade lock strikes (1940 to 1968) are not available.

Insect Screens

Insect Screen - Aluminum					
Insect Screen - Aluminum (Single)					
Note: Left hand screens will have (2) two latches, right hand screens will have (1) one latch.	Unit No.	Dimensions (w x h)	White		Green
			Left	Right	
	38024	39 7/8 × 23 5/64	8121401		0407008
	38030	39 7/8 × 31 5/64	0407210		0407010
	38038	39 7/8 × 39 5/64	0407212		0407012
	38044	39 7/8 × 47 5/64	0407216		0407016
	38050	39 7/8 × 55 5/64	0407220		0407020
	48024	25 13/16 × 23 5/64	8121402	8121403	
	48030	25 13/16 × 31 5/64	0407326	0407426	
	48038	25 13/16 × 39 5/64	0407328	0407428	
	48044	25 13/16 × 47 5/64	0407332	0407432	
	48050	25 13/16 × 55 5/64	0407336	0407436	
	48058	25 13/16 × 63 5/64	0407340	0407440	
	58024	31 13/16 × 23 5/64	8121404	8121405	
	58030	31 13/16 × 31 5/64	0407346	0407446	
	58038	31 13/16 × 39 5/64	0407348	0407448	
	58044	31 13/16 × 47 5/64	0407352	0407452	
	58050	31 13/16 × 55 5/64	0407356	0407456	
	58058	31 13/16 × 63 5/64	0407360	0407460	
	58064	31 13/16 × 71 5/64	0407364	0407464	

Primed Gliding Windows (1940 to 1971)

Standard Windows

Insect Screens

Insect Screen - Aluminum (Pair)				
	Unit No.	Dimensions (w x h)	White	Green
	48024	51 ⁷ / ₈ × 23 ⁵ / ₆₄	8121501	0407024
	48030	51 ⁷ / ₈ × 31 ⁵ / ₆₄	0407226	0407026
	48038	51 ⁷ / ₈ × 39 ⁵ / ₆₄	0407228	0407028
	48044	51 ⁷ / ₈ × 47 ⁵ / ₆₄	0407232	0407032
	48050	51 ⁷ / ₈ × 55 ⁵ / ₆₄	0407236	0407036
	48058	51 ⁷ / ₈ × 63 ⁵ / ₆₄	0407240	0407040
	58024	63 ⁷ / ₈ × 23 ⁵ / ₆₄	8121502	0407044
	58030	63 ⁷ / ₈ × 31 ⁵ / ₆₄	0407246	0407046
	58038	63 ⁷ / ₈ × 39 ⁵ / ₆₄	0407248	0407048
	58044	63 ⁷ / ₈ × 47 ⁵ / ₆₄	0407252	0407052
	58050	63 ⁷ / ₈ × 55 ⁵ / ₆₄	0407256	0407056
	58058	63 ⁷ / ₈ × 63 ⁵ / ₆₄	0407260	0407060
	58064	63 ⁷ / ₈ × 71 ⁵ / ₆₄	0407264	0407064

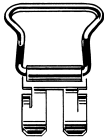
Insect Screen Pull		
		Order No.
		8121701
Strike - Screen / Metal		
	Note: Includes nails.	Order No.
		0337808

Frames

Frame Assembly

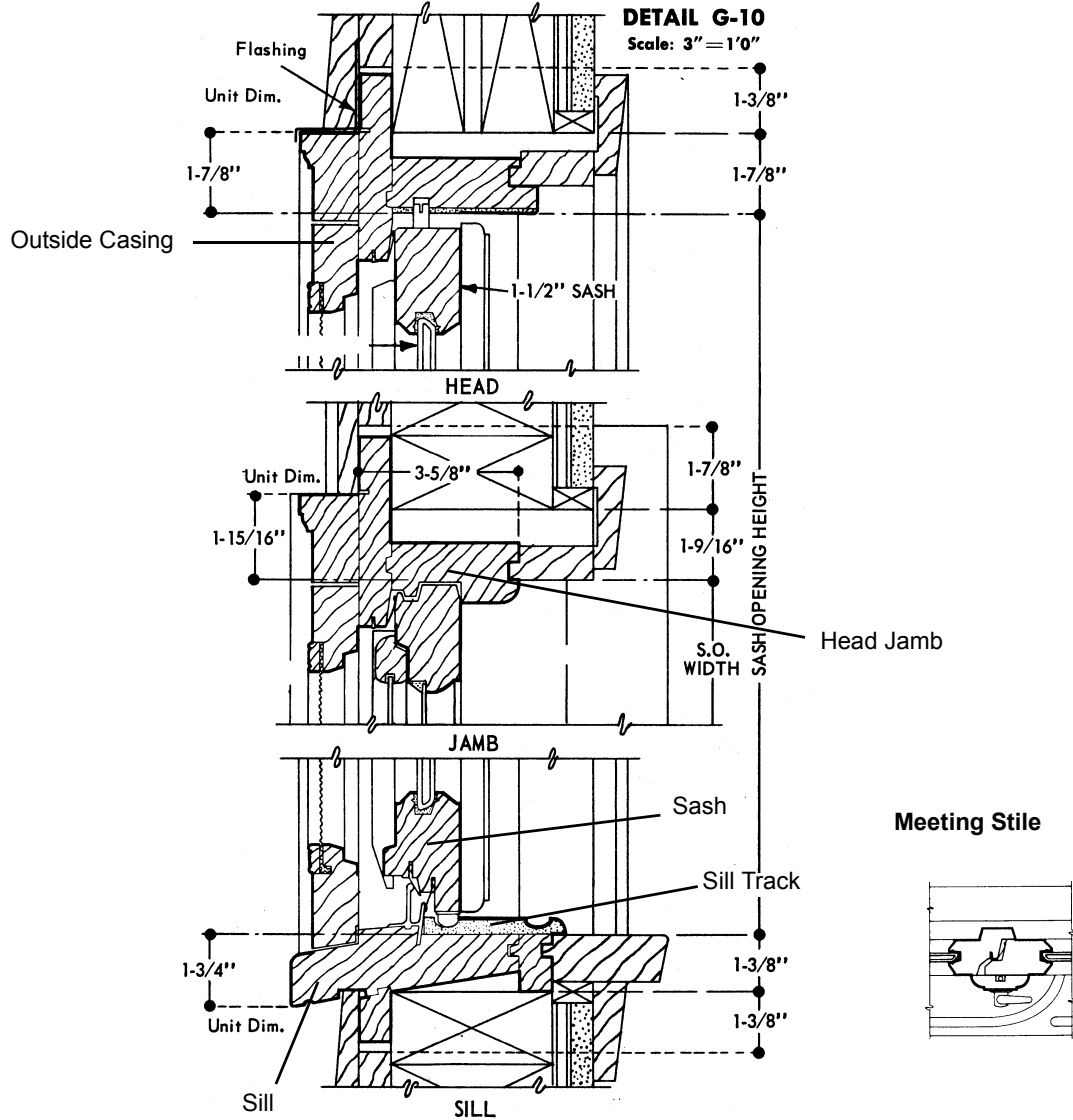

Primed Gliding Window Frame Assembly